

VICTOR - 1159B

COMPACT - 1800 W MSR



- **Type:** Followspot
- **Source:** 1800 W MSR
- **PSU:** Electronic - hot restrike - DMX
- **Optics:** 7° to 14,5° zoom
- **DMX-control of motorised dimmer shutter and lamp ignition**

Followspot

Compact but so powerful

With a combination of compact dimensions, high output to rival 2500 W followspots, hot restrike lamp, electronic PSU and DMX-control, Victor is perfect for rental companies. It has become the new benchmark followspot for large theatres, TV studios, fashion shows, concerts and touring.

Features

- **Fully closing iris cassette:** removable for fast, easy replacement; protective backplate for extended lifespan
- **Universal adjustable gobo holder:** a-size glass and metal gobos
- **Ergonomic dimmer control:** one-handed dim, pan and tilt
- **Smooth dimmer shutter:** retains flat beam and colour temperature when dimming
- **Remote DMX-control:** dMX-control of motorised dimmer shutter - effects synchronising remotely with pinpoint accuracy. Control from both local and DMX through 'Master' function
- **Frost filter:** on flip lever for quick soft-edge beam effect
- **Horizontal chopper (optional):** for masking control in TV studios and wide stages
- **Internal glass filter holder:** long term use of durable coloured, dichroic or textured glass
- **Individually removable colour frame:** gels replaced easily while colour cassette remains in place
- **Colour changer:** 6-way, self-cancelling boomerang colour-changer
- **Scroller:** standard scroller colour changer can be installed and powered from the unit through built-in XLR (24V+DMX) output connector
- **RJ NET:** ensures optimum operation capacities, providing a wide pallet of feedback information (dimming level, lamp hours, projector status...) on integrated LCD display
- **DMX remote controlled ignition**
- **Easy focus reference:** graduated scale on side of lantern; fast and easy refocusing
- **Adjustable yoke (optional):** for optimum overhead positioning
- **Fine balance:** precision positioning and smooth operation even with the smallest movements
- **Stand:** perfectly weighted for maximum stability with smooth rotation for optimum performance. Easy set up; triple safety system for extra security

Optical

- **Factory set optical train:** travels safely within followspot and requires no time-consuming realignment on arrival. Uniform beam on all followspots of same type
- **SX optical system:** double condenser optics for exceptional optical quality
- **Gobo :** excellent gobo projection
- **Variable zoom optics:** sharp focus at every beam angle

Construction

- **Made in France :** fully manufactured in Robert Juliat premises retaining complete control over all aspects of quality
- **Separate PSU:** compact for easy handling and rapid maintenance
- **Bodywork:** strong sheet metal construction for durability
- **Ergonomic wrap-around handle:** comfort, safety and practicality from all operating positions
- **Moving parts:** smooth at all times, even when hot
- **Captive knobs and handles:** additional security when working at height or in transit
- **Easy access to all parts:** easy cleaning, re-lamping and maintenance
- **Removable assemblies:** fast-plug cable connectors and complete component assemblies (mirror, condenser set and lamp house assembly) save maintenance and cleaning time
- **Safety:** safety switch for secure access to the lamp

Picture:1159B + FRO/1117PV

DSEN104_1159B - 18/05/2017

Robert Juliat reserves the right to change or alter any of the items detailed on this page, to increase or improve manufacturing techniques without prior notice.

Robert Juliat S.A.S., 32 rue de Beaumont, 60530 Fresnoy-en-Thelle - France
Telephone : +33 (0)3 44 26 51 89 - fax : +33 (0)3 44 26 90 79 - info@robertjuliat.fr
www.robertjuliat.com



ROBERT JULIAT

Source



- **Lamp type:** Discharge
- **Power:** 1800 W
- **Socket:** SFC 15.5-6
- **Hot re-strike:** yes

Admissible lamps	Power *	Lumen output*	Colour temperature*	Life*	CRI* (min)
MSR 1800W DE (Philips)	1 800 W	145 000 lm	6000K	750 h	>85
KHD 1800W HR/DE (KLS)	1 800 W	155 000 lm	6000K	750 h	90

(*) manufacturer's data

Optics

Characteristics

- **Type:** Zoom
- **Beam range:** 7° to 14,5°
- **Focal length:** 283 - 589 mm

Gel filter

- **Shape:** Circle
- **Standard size:** 210 mm (8.3 in)

Gobo

- **Size:** A
- **Material:** Metal
Glass

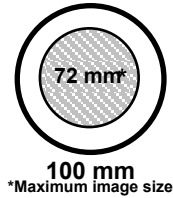

Photometrics

with MSR 1800W DE (Philips) source

• Optics @ 7°

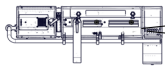

7°

Field angle
3%

Beam intensity
2 300 000 cd

Distance	20 m	30 m	40 m	50 m	60 m	70 m
Diameter	2.4 m	3.7 m	4.9 m	6.1 m	7.3 m	8.6 m
Illumination	5 800 lux	2 600 lux	1 450 lux	930 lux	640 lux	470 lux
Distance	65 ft	100 ft	130 ft	165 ft	195 ft	230 ft
Diameter	8 ft	12.2 ft	15.9 ft	20.2 ft	23.9 ft	28.1 ft
Illumination	550 fc	240 fc	140 fc	85 fc	65 fc	44 fc

• Optics @ 14.5°

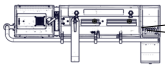

14.5°

Field angle
3%

Beam intensity
765 000 cd

Distance	20 m	30 m	40 m	50 m	60 m	70 m
Diameter	5.1 m	7.6 m	10.2 m	12.7 m	15.3 m	17.8 m
Illumination	1 950 lux	860 lux	480 lux	310 lux	220 lux	160 lux
Distance	65 ft	100 ft	130 ft	165 ft	195 ft	230 ft
Diameter	16.5 ft	25.4 ft	33.1 ft	42 ft	49.6 ft	58.5 ft
Illumination	190 fc	80 fc	46 fc	29 fc	21 fc	15 fc

Remote control

- **Data protocol:** USITT DMX512-A

- **Data IN connector:** 5 pins XLR male
- **Data OUT connector:** 5 pins XLR female



• DMX chart:

Mode 1 (2 channels)

Mode control
Dimmer

Mode 2 (3 channels)

Mode control
Dimmer
Dimmer fine

Mode 3 (3 channels)

Mode control
Dimmer
Dimmer master

Mode 4 (4 channels)

Mode control
Dimmer
Dimmer fine
Dimmer master

Dimensions and weight

Unit

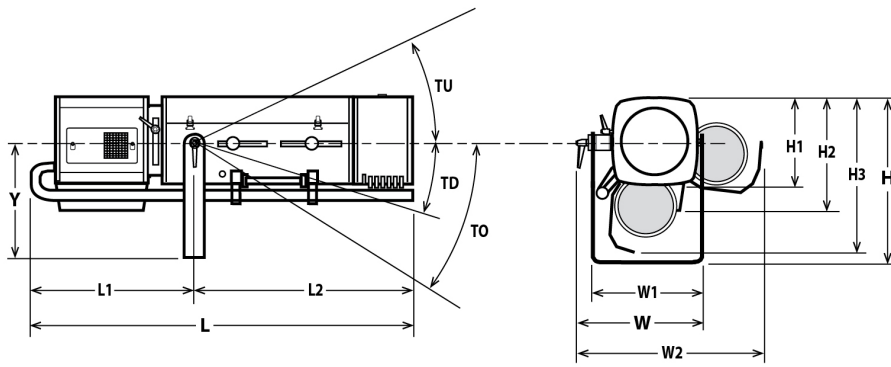

Weight: 36 kg (79.2 lbs)

Height	Length	Width	Yoke	Tilt	Option
H= 450 mm (17.7 in)	L= 1260 mm (49.6 in)	W= 410 mm (16.1 in)	Y= 325 mm (12.8 in)	TU= 45°	TO= TBD°
H1= 250 mm (9.8 in)	L1= 580 mm (22.8 in)	W1= 350 mm (13.8 in)		TD= 40°	
H2= 340 mm (13.4 in)	L2= 680 mm (26.8 in)	W2= 570 mm (22.4 in)			
H3= 460 mm (18.1 in)					

Shipping

• **Weight :** 84.4 kg (185.7 lbs)

• **Volume :** .58 m³ (20.48 ft³)

PSU

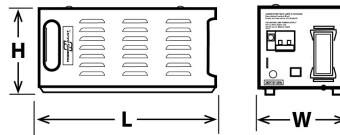

Width: W= 185 mm (7.3 in)
Height: H= 200 mm (7.9 in)
Length: L= 590 mm (23.2 in)
Weight: 13.2 Kg (29 lbs)

Installation

- **Minimum distance to illuminated surface:** 3.5 m (11.5 ft)
- **Operating position:**

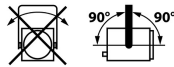

Warranty

- **Period: 2 years**
See General Sales Condition on website

Approvals



Construction

- **Housing:** Steel sheet - Aluminium
- **Colour:** Black
- **Cooling:** Low noise fan
- **Maximum ambient temperature (Ta):** 40°C (104°F)
- **Maximum case temperature (Tc):** 230°C (446°F)
- **Total heat dissipation:** 6 963 BTU/h
- **Protection rating:** 20

- **PSU housing:** Steel sheet - Aluminium
- **PSU colour:** Black
- **PSU cooling:** Fan
- **PSU maximum ambient temperature (Ta):** 40°C (104°F)
- **PSU maximum case temperature (Tc):** 50°C (122°F)

Electrical compatibility

- 220/230 V - 50 Hz
- 245 V - 50 Hz
- ~~410/420 V - 60 Hz~~
- 208 V - 60 Hz
- 220 V - 60 Hz
- ~~400 V - 50 Hz~~
- ~~400 V - 60 Hz~~
- Selector: automatic detection

Power input



- **Type:** removeable power cord with Neutrik PowerCon® (ref. NAC3FCA) connector (included)
- **Cable:** H07RNF 3G1.5
- **Length:** 3 m (9,8 ft)
- **Power connector:** CEE 7/7 (2P+E NF/Schuko)

Power consumption

Voltage	Frequency	Current	Power	Power factor
230 V	50 Hz	8.9 A	2040 W	,98
208 V	60 Hz	?	2040 W	,97
245 V	50 Hz			TBD

Power Supply Unit

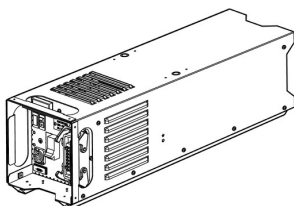





- **PSU:** Separate - Electronic PSU - Flicker free with PFC
- **Lighting unit / PSU cable:** Removable cable - length: 3 m (9,8 ft)
Type: 18G1,5 JZ 602-RC (CE-UL/CSA) with 16x16A+E Harting Han® connectors
- **Maximum distance between lighting unit and PSU:** 25 m (82 ft)
- **Control:** Local / DMX
- **Protection:** Mains: 16A 2P2D - C curve breaker / Electronic: 2A 5x20 time-delay fuse









Model

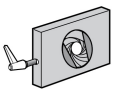











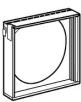

1159B	1800 W MSR Followspot - 1159B Victor - 7/14,5° - Electronic PSU - DMX dimmer and lamp control
--------------	---

Options

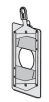
PCP1716A	16A blue 2P+E 6h IEC60309 power connector	
FRO/1117PV	Heavy duty adjustable yoke	
PG80	Ø80mm chopper kit (G80+ GR120+ adaptation kit)	
M210TM	6 ways "push/pull" colour changer	
CAG/C	Left side controls (Iris/Dimmer/Frost/Colour changer)	
FC1459	Flight-case for Compact range / GT stand / P.S.U. / accessories - Dim: 1340x710x700mm - Poids: 55 Kg	

Accessories

KHD 1800W HR/DE	KHD 1800W HR/DE - KLS SFc 15.5-6 1800W 750h 6000K lamp 1 included	
CCU1	Full closing iris cassette - Weight: 1,33 Kg 1 included	
PF1011	Ø210 mm metal filter holder 6 included	
SGUP	Universal "A" size gobo-holder (metal, glass, frosted glass) 1 included	
FACM100	Ø97mm UV/IR filter with holder 1 included	
VDM100	Ø97mm frosted glass with holder 1 included	
M210B	6 ways "boomerang" colour changer - Weight: 3,36 Kg 1 included	
TC1149	Tool case with spare parts - Weight: 1,65 Kg 1 included	
GT1000	Tripod stand - SWL: 40 Kg - max. height: 1550 mm - Weight: 9,27 Kg	
GT4000	Tripod stand with safety chain - SWL: 130 Kg - max. height: 1030 mm - Weight: 7,91 Kg	

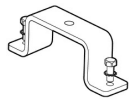
GT4000S	Tripod stand without safety chain - SWL: 130 Kg - max. height: 1030 mm - Weight: 8,65 Kg	
JPP	Monopod stand for overhead followspot - Weight: 3,6 Kg	
T1000	TV spigot with followspots swivel head - Weight: 1,82 Kg	
T4000	Followspot mount for Ø50mm pipe (suspension or overhead) - SWL= 100 Kg - Weight: 4,88 Kg	
CAV700A	Double slot front cassette for 215x215mm accessories - Weight: ,52 Kg	
FCM100	Ø97mm CTO correction filter (5500K → 3400K) with holder	
VD120	120x120mm frosted glass	
FRO/1017PD	Heavy duty adjustable yoke - Weight: 4,33 Kg	
Kit G80	Ø80mm chopper kit (G80+ GR120+ adaptation kit) - Weight: ,69 Kg	
M210T	6 ways "push/pull" colour changer - Weight: 3,67 Kg	
M210TVCL	Light shield for M210T push/pull colour changer - Weight: 1,98 Kg	
Kit TELRAD	Telrad followspot sight with raiser and universal mounting kit - Weight: 1,23 Kg	
SDUP	Followspot cue sheet holder with universal mounting kit	
P1FCAN	Remote controller for dimming shutters - Weight: ,44 Kg	
FC1459/S	Flight-case for Compact range / GT stand / P.S.U. / accessories - Weight: 55 Kg	
OmegaP	Omega bracket with screw for PSU	
W/GT800	Set of 3 wheels for GT800/1000 stand - Weight: 2,33 Kg	