

Version 3
December 2004

L-ACOUSTICS® ARCS®
OPERATOR MANUAL



FOREWORD

Thank you for purchasing the ARCS® sound reinforcement system.

This manual is intended to provide you with the information you require to install and operate ARCS in a wide variety of professional sound reinforcement applications.

Specific information and recommendations are included regarding system design, sound design and installation procedures. We are confident that the information provided in this manual will be sufficient for most applications, however, should you require further assistance your local distributor or L-ACOUSTICS® are available to provide additional technical support.

MANUAL ORGANIZATION

- ◆ The Introduction gives a presentation of Wavefront Sculpture Technology and the ARCS system
- ◆ Chapter 1 introduces the elements of the ARCS system
- ◆ Chapter 2 details ARCS power amplification and cabling
- ◆ Chapter 3 describes preset selection and system operation
- ◆ Chapter 4 discusses sound design aspects
- ◆ Chapter 5 outlines ARCS installation procedures
- ◆ Chapter 6 discusses system operation and maintenance procedures
- ◆ Chapter 7 provides ARCS specifications

TABLE OF CONTENTS

| | |
|--|-----------|
| FOREWORD | 1 |
| MANUAL ORGANIZATION | 1 |
| TABLE OF CONTENTS | 2 |
| LIST OF FIGURES | 3 |
| LIST OF TABLES | 3 |
| 0. INTRODUCTION | 5 |
| The Sound Reinforcement Problem | 5 |
| WAVEFRONT SCULPTURE TECHNOLOGY® | 5 |
| The ARCS® Sound Reinforcement System | 7 |
| 1. THE ARCS SYSTEM | 9 |
| 1.1 ARCS SYSTEM COMPONENTS | 9 |
| 1.2 ARCS SPECIFICATIONS..... | 15 |
| 1.3 ARCS Accessories..... | 16 |
| ARCPLA..... | 16 |
| ARCSCOV | 16 |
| 1.4 ARCS Rigging Components | 16 |
| ARCOUPL..... | 16 |
| BUMP 3, LIFTBAR..... | 17 |
| ARCBUMP..... | 18 |
| ARCSTRAP | 19 |
| 2. POWERING ARCS | 20 |
| 2.1 CONNECTORS and CABLES | 23 |
| 3. ARCS CONTROL AND PROCESSING | 23 |
| 3.1 General Description of ARCS Presets..... | 24 |
| 3.2 ARCS Preset Policy..... | 24 |
| 3.3 Guidelines Regarding System Protection | 25 |
| 3.4 ARCS PRESET Libraries | 26 |
| 4. SOUND DESIGN | 33 |
| 4.1 APPLICATIONS | 33 |
| 4.2 ARRAY AIMING | 34 |
| 4.3 ARCS COVERAGE MODELING USING SOUNDVISION | 36 |
| 4.4 FRONT OF HOUSE APPLICATIONS | 40 |
| 4.4.1 SINGLE ROW VERTICAL ARRAYS..... | 41 |
| 4.4.2 SINGLE ROW 360 DEGREE | 42 |
| 4.4.3 DOUBLE ROW ARRAYS | 43 |

| | |
|---|-----------|
| 4.4.4 HORIZONTALLY-FLOWN ARRAYS | 44 |
| 4.5 MONITOR APPLICATIONS..... | 45 |
| 4.5.1 MONITOR SIDE-FILL | 45 |
| 4.6 COMPLEMENTARY FILL APPLICATIONS..... | 46 |
| 4.6.1 FLOWN/STACKED CENTRE FILL..... | 47 |
| 4.6.2 STACKED STEREO INFILL | 48 |
| 4.6.3 OFFSTAGE FILL..... | 49 |
| 4.7 DELAY SYSTEMS | 50 |
| 4.8 Using ARCS with Subwoofers..... | 51 |
| a) Combining ARCS With Subwoofers | 51 |
| b) Ground Stacked Systems | 52 |
| c) Separate Flown ARCS Array with Ground Stacked Subwoofers | 53 |
| 5. INSTALLATION PROCEDURES | 54 |
| 5.1 INSTALLATION OF A SINGLE ROW FLOWN SYSTEM..... | 54 |
| 5.2 INSTALLATION OF A DOUBLE ROW FLOWN SYSTEM..... | 58 |
| 5.3 ARCBUMP INSTALLATION | 60 |
| 5.4 Safety Rules..... | 63 |
| 6 ARCS SYSTEM OPERATION | 65 |
| 6.1 RECOMMENDED MAINTENANCE PROCEDURES | 65 |
| 6.2 SPARE PARTS..... | 66 |
| 7 SPECIFICATIONS | 67 |

LIST OF FIGURES

| | |
|---|----|
| Figure 1: Conventional horn array versus an array of ARCS DOSC waveguides..... | 7 |
| Figure 2: ARCS Configuration Examples | 8 |
| Figure 3: ARCS plus accessories | 9 |
| Figure 4: ARCS Rigging Accessories | 10 |
| Figure 5: ARCS Subwoofer Options..... | 11 |
| Figure 6: Loudspeaker cabling options | 11 |
| Figure 7: ARCS Power Amplification Options..... | 12 |
| Figure 8 : ARCS System Cabling Details..... | 14 |
| Figure 9: ARCS Enclosure..... | 15 |
| Figure 10: ARCPLA..... | 16 |
| Figure 11: ARCSCOV | 16 |
| Figure 12: ARCOUPL | 17 |
| Figure 13: BUMP3, LIFTBAR Rigging Accessories..... | 17 |
| Figure 14: Examples of BUMP3 Requirements for 4 and 5 Element ARCS Arrays..... | 18 |
| Figure 15: ARCBUMP | 18 |
| Figure 16: ARCSTRAP | 19 |
| Figure 17: Example of ARCSTRAP, BUMP3, LIFTBAR Requirements for a 2 x 4 Array..... | 19 |
| Figure 18: MLS switches on the rear panel of LA24a and LA48a amplifiers..... | 22 |
| Figure 20: ARRAY Cutview simulation of an ARCS installation for theatrical sound reinforcement..... | 35 |
| Figure 21: AUTOCAD utilities for representing ARCS horizontal and vertical coverage..... | 35 |
| Figure 22: Plan view SPL mappings at octave band frequencies for 4 ARCS arrayed vertically | 37 |
| Figure 23: Impact coverage and SPL mappings for 4 ARCS | 38 |

| | |
|---|----|
| Figure 24: Impact coverage and A-weighted SPL mappings for the theatrical sound design example..... | 40 |
| Figure 30: Stacked ARCS Side-fill (3 x ARCS, 1 x SB218) plus stereo front-fill system..... | 45 |
| Figure 31: Flown ARCS Sidefill (2+2 ARCS per side) plus offstage fill system..... | 45 |
| Figure 32: Stereo in-fill plus side fill configuration | 46 |
| Figure 33: Distributed ARCS fill application (3 clusters of 4 x ARCS in an LCR configuration)..... | 46 |
| Figure 38 : ARCS Offstage Fill Plus Side Fill Example..... | 49 |
| Figure 39: ARRAY cutview simulation of an ARCS FOH system with delays..... | 50 |
| Figure 40: L-ACOUSTICS Subwoofer Continuous Unweighted SPL Comparison..... | 51 |
| Figure 41: Illustration of subwoofer time alignment..... | 53 |
| Figure 42: Rigging Procedure for a 4 Enclosure ARCS Array | 56 |
| Figure 43: Rigging Procedure for a 3 Enclosure ARCS Array | 57 |
| Figure 44: Rigging procedure for a double row (4+4) enclosure ARCS array..... | 60 |
| Figure 45: ARCBUMP rigging procedure for a 3 enclosure horizontal ARCS array..... | 62 |
| Figure 46: ARCS line drawing | 68 |
| Figure 47: ARCS Rigging Certification | 69 |
| Figure 48 : BUMP3 Rigging Certification | 70 |
| Figure 49 : LIFTBAR Rigging Certification | 71 |
| Figure 50 : ARCSTRAP Rigging Certification..... | 72 |
| Figure 51 : ARCBUMP Rigging Certification..... | 73 |

LIST OF TABLES

| | |
|---|----|
| Table 1: Load and Power Ratings for ARCS | 20 |
| Table 2a: Recommended Power Amplification and MLS switch settings for ARCS low section | 21 |
| Table 2b: Recommended Power Amplification and MLS switch settings for ARCS high section | 21 |
| Table 3: L-ACOUSTICS LA24a and LA48a Power Amplifier Specifications | 22 |
| Table 4: Maximum Recommended Length for Damping Factor > 20..... | 23 |
| Table 5: XTA DP226 Presets | 28 |
| Table 6: XTA DP224 Presets | 28 |
| Table 7: BSS 334 Minidrive Presets | 29 |
| Table 8: BSS 336 Minidrive Presets..... | 30 |
| Table 9: L-ACOUSTICS modules for Lake Contour..... | 31 |
| Table 10: BSS 366 Omnidrive Presets..... | 30 |
| Table 11: L-ACOUSTICS Subwoofer Specification Summary..... | 51 |
| Table 12: Subwoofer and Low Section Processing for ARCS 3-Way Presets | 52 |
| Table 13: ARCBUMP Pick Point Hole Number versus Tilt Angle for 2, 3 or 4 ARCS..... | 63 |
| Table 14: ARCS Rigging Reference Chart..... | 64 |

0. INTRODUCTION

The Sound Reinforcement Problem

Effectively covering an audience is the goal of any sound reinforcement system design. This is straightforward in small spaces where a left/right stereo configuration is suitable provided that the available power is sufficient, i.e., a stereo pair of loudspeakers is a relatively easy system to install and the results are fairly predictable. Things become more complex when larger audience area coverage is required and there are two possible approaches:

1) Multiplying the number of sound sources by dividing the audience into areas which are covered by individual sources. In this case, the Haas effect is exploited and delay lines can also be introduced to provide proper localization. This is the distributed sound reinforcement, or multiple sound source approach and L-ACOUSTICS MTD or XT coaxial loudspeakers are highly suited to this type of sound design.

2) Coupling a number of individual sound sources to form a loudspeaker array with the objective that each array becomes the equivalent of a single sound source.

Typically, the multiple sound source concept is best suited to medium-sized venues, whereas in very large venues it can be impractical and expensive to install and tune a large number of loudspeakers with many delay lines. In addition, the distributed sound reinforcement approach can be unsuitable for open air applications or in a daily touring situation.

Although coupling or arraying a number of loudspeakers to provide the required sound pressure and angular coverage has long been regarded as the most practical approach for high power sound reinforcement, the condition that "each array becomes the equivalent of a single sound source" has often been comprised or overlooked.

When arrayed, most conventional speakers do not couple acoustically at frequencies having a wavelength smaller than the physical size of the enclosure. Typically, problems occur at mid and high frequencies, accounting for roughly two thirds of the audio spectrum. The net result is a chaotic sound field that exhibits severe comb filtering, uneven frequency response that varies with listener position and a significant loss of energy. In practical terms, this results in efficiency and intelligibility losses plus uneven coverage.

WAVEFRONT SCULPTURE TECHNOLOGY®

Conditions for achieving proper coupling of individual arrayed sound sources have been defined by Dr. Christian Heil and Professor Marcel Urban, in "Sound Fields Radiated by Multiple Sound Source Arrays", preprint 3269, presented at the 92nd Audio Engineering Society (AES) Convention in Vienna, 1992.

The theory that was developed defines the acoustic coupling conditions required for effectively arraying individual sound sources. Relevant parameters include: wavelength, the shape of each source, the surface area of each source and the source separation.

WST coupling conditions can be summarized as follows:

An assembly of individual sound sources arrayed with regular separation between the sources on a plane or curved, continuous surface is equivalent to a single sound source having the same dimensions as the total assembly if, and only if, one of the two following conditions is fulfilled:

1) Shape: The combined surface area of the wavefronts radiated by the individual sources of the array fills at least 80% of the target radiating surface area (see also Condition 3).

2) Frequency: The step or source separation, defined as the distance between the acoustic centers of the individual sources, is smaller than half the wavelength at all frequencies over the bandwidth of operation (generally, this criteria is satisfied at lower frequencies since the wavelengths are sufficiently large).

These two conditions form the basis of Wavefront Sculpture Technology (WST).

Additional conditions were published in the AES Journal paper "Wavefront Sculpture Technology", JAES Vol. 51, No. 10, October 2003. The first two WST conditions were re-derived (based on an intuitive approach using Fresnel analysis) and it was shown that:

3) *Deviation from the ideal, target wavefront (flat or curved) must be less than a quarter wavelength at the highest operating frequency (this corresponds to less than 5 mm curvature at 16 kHz)*

4) *For curved arrays, enclosure tilt angles should vary in inverse proportion to the listener distance (geometrically this is equivalent to shaping variable curvature arrays to provide equal spacing of individual element impacts on the audience listening plane)*

5) *Limits exist concerning the size of each enclosure, the minimum allowed listener distance and the relative angles that are allowed between enclosures.*

At higher frequencies, the only way to couple individual sound sources is to make them behave like a single source. Practically, this means creating a continuous wavefront, which can be achieved using individual sound sources only if they meet the requirements defined by WST Conditions 1 and 3. To create a continuous wavefront, the total area of the discontinuities between adjacent individual wavefronts must be less than 20% of the total active radiating surface area of the two wavefronts and the deviation of any point on the wavefront surface with respect to the location of the theoretically equivalent continuous wavefront must be less than a quarter wavelength of the highest frequency to be reproduced.

The key to satisfying WST criteria at higher frequencies is a proprietary L-ACOUSTICS waveguide that is used to load a conventional compression driver. This DOSC[®] waveguide was invented by Dr. Christian Heil and is patented world-wide. DOSC stands for "Diffuseur d'Onde Sonore Cylindrique" – in English this means Cylindrical Sound Wave Generator.

Essentially, the DOSC waveguide permits fulfilment of the 1st and 3rd WST conditions at higher frequencies. For traditional horn-loaded systems, coherent summation is not possible at higher frequencies since the wavelength becomes progressively smaller than the physical separation between horn and driver assemblies and neither of the first two WST conditions can be satisfied.

The first loudspeaker system designed based on the principles of WST theory is the world-famous V-DOSC[®] - a system capable of generating cylindrical wavefronts and meeting WST coupling conditions for angles of 0° to 5° between adjacent boxes. Among other features, V-DOSC has been established as the sound reinforcement system providing the longest throw ever and can be considered as the first modern generation line source array.

It can be argued that V-DOSC is responsible for a paradigm shift in the sound reinforcement industry away from traditional trapezoidal loudspeaker arrays but it should be noted that there is a big difference between a line source array (such as V-DOSC, dV-DOSC or ARCS) and other line array systems on the market today. Whether a line array correctly behaves as a line source array depends on the extent to which the 5 WST conditions outlined in "Wavefront Sculpture Technology", JAES Vol. 51, No. 10, October 2003 are satisfied. For further details, please refer to this paper as a complete explanation of WST theory is beyond the scope of this manual.

The ARCS® Sound Reinforcement System

Requirements for smaller array configurations and shorter throw distances - but with the same quality standards as set by V-DOSC - led to the design of ARCS. Since ARCS generates a modular, curved wavefront, ARCS stands for "Arrayable Radial Coherent System". While V-DOSC uses variable curvature arrays to perform wavefront sculpture in the vertical plane, ARCS operates in the horizontal (or vertical) plane and generates a modular, constant curvature wavefront with a radius of wavefront curvature corresponding to 1.15 meters.

The patented DOSC waveguide designed exclusively for ARCS loads a compression driver that is operated from 900 - 20k Hz. This waveguide produces a radiated wavefront that covers the total width of the enclosure and has an arc's shape of 22.5°. Individual radiated wavefronts are curved rectangular strips that match the trapezoidal angle of each ARCS enclosure and, as a result, the wavefront radiated at high frequencies by an ARCS array is continuous with an arc's shape that is equal to the $N \times 22.5^\circ$ (where N is the number of enclosures). For example, four ARCS enclosures provides 90° horizontal coverage.

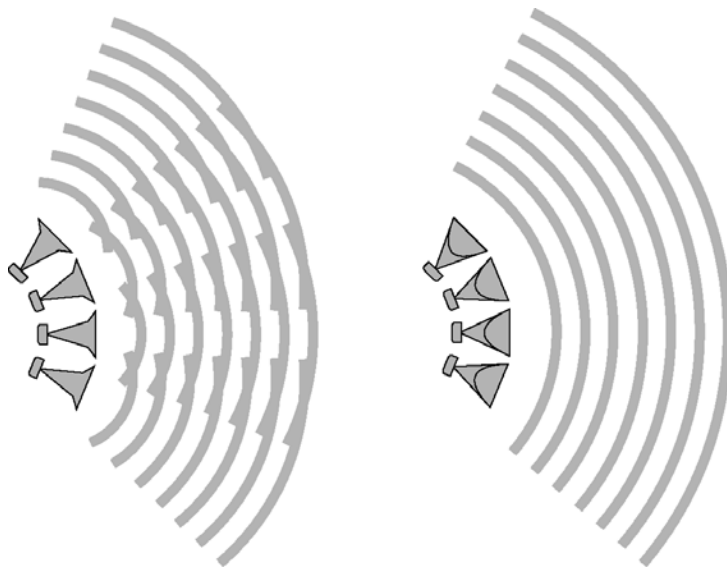

Figure 1: Conventional horn array versus an array of ARCS DOSC waveguides

ARCS is designed with a trapezoidal shape for lateral coupling of adjacent cabinets and enclosures are mechanically joined to form a fan-shaped, tightly-wrapped array. To match the coverage of the wavefront radiated by the DOSC waveguide, the angle of each enclosure is 22.5°.

At lower frequencies, the size of the ARCS enclosure allows for perfect coupling due to the size of wavelengths below 800 Hz, i.e., the distance between acoustic centers of adjacent 15" loudspeaker components is always less than half a wavelength over the entire low section operating bandwidth, thus satisfying WST Condition #2.

The ARCS system therefore meets the conditions defined by Wavefront Sculpture Technology and provides, when arrayed in any number, the equivalent of single loudspeaker behavior. The net result is exceptionally even frequency response over the entire array's coverage pattern – a feature which is characteristic of Wavefront Sculpture Technology.

For optimizing the geometrical coverage of typical audiences, the vertical coverage of ARCS is not symmetrical, but provides 40° in one direction and 20° in the opposite direction. The advantages inherent in this geometry are further discussed throughout the course of this manual.

In summary, ARCS is the only medium format system that provides a coherent, single point source sound field. This makes ARCS highly suitable for medium scale sound reinforcement applications where multiple sound source designs are not powerful enough or impractical and, in terms of throw distance, the extreme capabilities of V-DOSC or dV-DOSC are not required.



4 ARCS Enclosures providing 90 degree horizontal coverage and +20/-40 degree vertical coverage (inverted horizontal orientation)



8 ARCS Enclosures providing 90 degree horizontal coverage and +40/-40 degree vertical coverage (coupled double row configuration)



4 ARCS Enclosures providing -20/+40 degree horizontal coverage by 90 degrees vertical coverage (vertical orientation)

Figure 2: ARCS Configuration Examples

1. THE ARCS SYSTEM

The ARCS system consists of: ARCS enclosures, SB118, SB218 or dV-SUB subwoofers, an approved digital processor with OEM factory presets, ARCPLA front dollies, ARCSCOV protective covers, ARCOUPL connecting bars, ARCSTRAP vertical linking elements for flying double row configurations, BUMP3 and LIFTBAR rigging accessories. Please note that amplifier racks plus loudspeaker cables are not specified but should meet the minimum specification requirements outlined in Section 2.

A block diagram of a typical ARCS FOH system is shown below in Figure 3. ARCS system components are described in Section 1.1 and shown in Figure 4.

1.1 ARCS SYSTEM COMPONENTS

LOUDSPEAKER ENCLOSURES

(1) ARCS

Active 2-way loudspeaker meeting Wavefront Sculpture Technology Criteria, containing one 15" loudspeaker and a 1.4" exit (3" voice coil) high frequency compression driver mounted on a DOSC waveguide, 22.5 degree by +40 / -20 degree (asymmetrical) coverage.

(2) ARCSCOV

Protective cover for ARCS enclosures

(3) ARCPLA

Removable front dolly with castors



Figure 3: ARCS plus accessories

ARCS RIGGING ACCESSORIES

(4) ARCOUPL

Pair of coupling bars (provided with shackles) for physical attachment of adjacent ARCS enclosures in the vertical orientation.

Note: when ARCS enclosures are flown vertically, DOSC waveguides are coupled in the horizontal plane.

(5) BUMP3

Flying bumper for rigging an ARCS array. Weight is 3.8 kg (8.4 lbs). One BUMP3 is required to fly 2 or 4 cabinets. Two BUMP3 and one LIFTBAR are required to fly 1, 3, 4, 6 or 8 enclosures.

(6) LIFTBAR

Rigging bar for use with 2 x BUMP3 (provided with 3 shackles)

(7) ARCBUMP

Rigging accessory for flying up to 4 ARCS in the horizontal orientation (provided with 6+6 safety steels for attachment between all front and rear ARCOUPL shackles, two ARCOUPL, two shackles).

Note: when ARCS enclosures are flown horizontally, DOSC waveguides are coupled in the vertical plane.

(8) ARCSTRAP

Vertical linking elements for flying double row ARCS configurations (ARCSTRAP is provided in pairs for front and rear attachment).

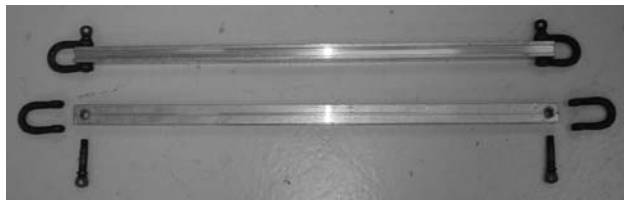

ARCOUPL



ARCBUMP



BUMP3



LIFTBAR



ARCSTRAP

Figure 4: ARCS Rigging Accessories

SUBWOOFER ENCLOSURES

(9) SB118

Dual-vented bandpass-loaded, single 18" subwoofer for high level, extended bandwidth

(10) SB218

Front-loaded, bass-reflex design, dual 18" subwoofer for high level, extended bandwidth

(11) dV-SUB

Dual-vented bandpass-loaded, triple 15" subwoofer for high level, low frequency extension



SB218



SB118



dV-SUB

Figure 5: ARCS Subwoofer Options

LOUDSPEAKER CABLING

(12) SP.7

Loudspeaker link cable, 4 conductor, 4 mm² conductor cross-section, 0.7 m (2 ft) length, equipped with Speakon connectors (for parallel connection of ARCS enclosures).

(13) SP7

Loudspeaker cable, 4 conductor, 4 mm² conductor cross-section, 7 m (20 ft) length, equipped with 2 x Speakon connectors.

(14) SP25

Loudspeaker cable, 4 conductor, 4 mm² conductor cross-section 25 m (80 ft) length, equipped with 2 x Speakon connectors.

(15) CC4FP

Female/female 4 conductor Speakon barrel extension adapter.



SP.7



SP7



SP25



CC4FP

Figure 6: Loudspeaker cabling options

AMPLIFICATION OPTIONS

(16) L-ACOUSTICS LA17a

Compact, light weight two-channel power amplifier (2 rack units, 8 kg), 430 watts per channel into 8 ohms, 840 watts per channel into 4 ohms.

(17) L-ACOUSTICS LA24a

Compact, light weight two-channel power amplifier (2 rack units, 10 kg), 1100 watts per channel into 8 ohms, 1500 watts per channel into 4 ohms.

(18) L-ACOUSTICS LA48a

Compact, light weight two-channel power amplifier (2 rack units, 10 kg), 1300 watts per channel into 8 ohms, 2300 watts per channel into 4 ohms.

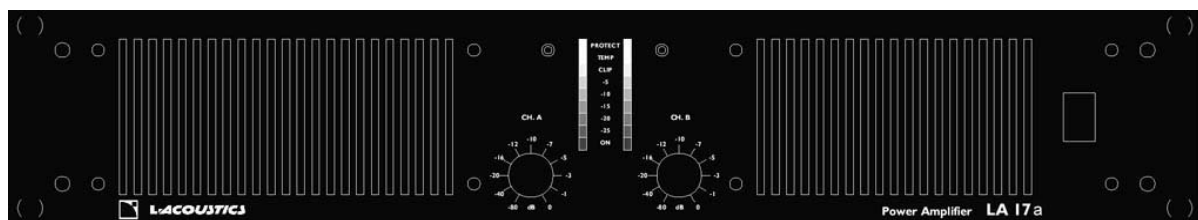

L-ACOUSTICS LA17a

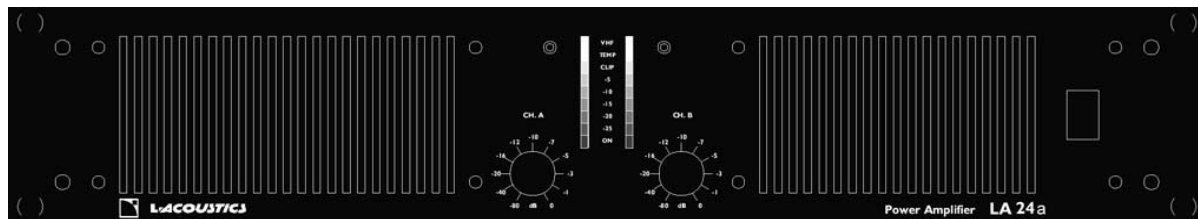

L-ACOUSTICS LA24a

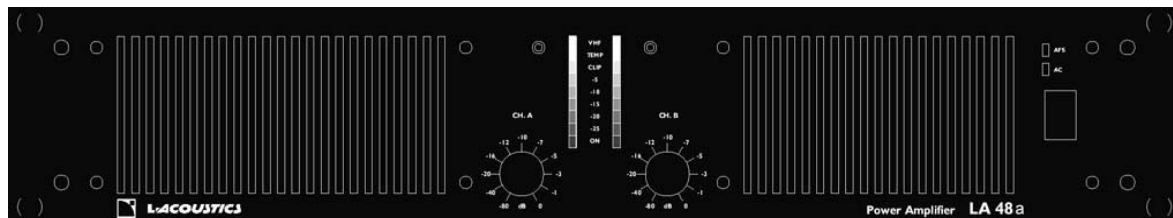

L-ACOUSTICS LA48a

Figure 7: ARCS Power Amplification Options

Note: for full technical details on L-ACOUSTICS LA amplifiers, please see their respective user manuals (available for download on: www.l-acoustics.com)

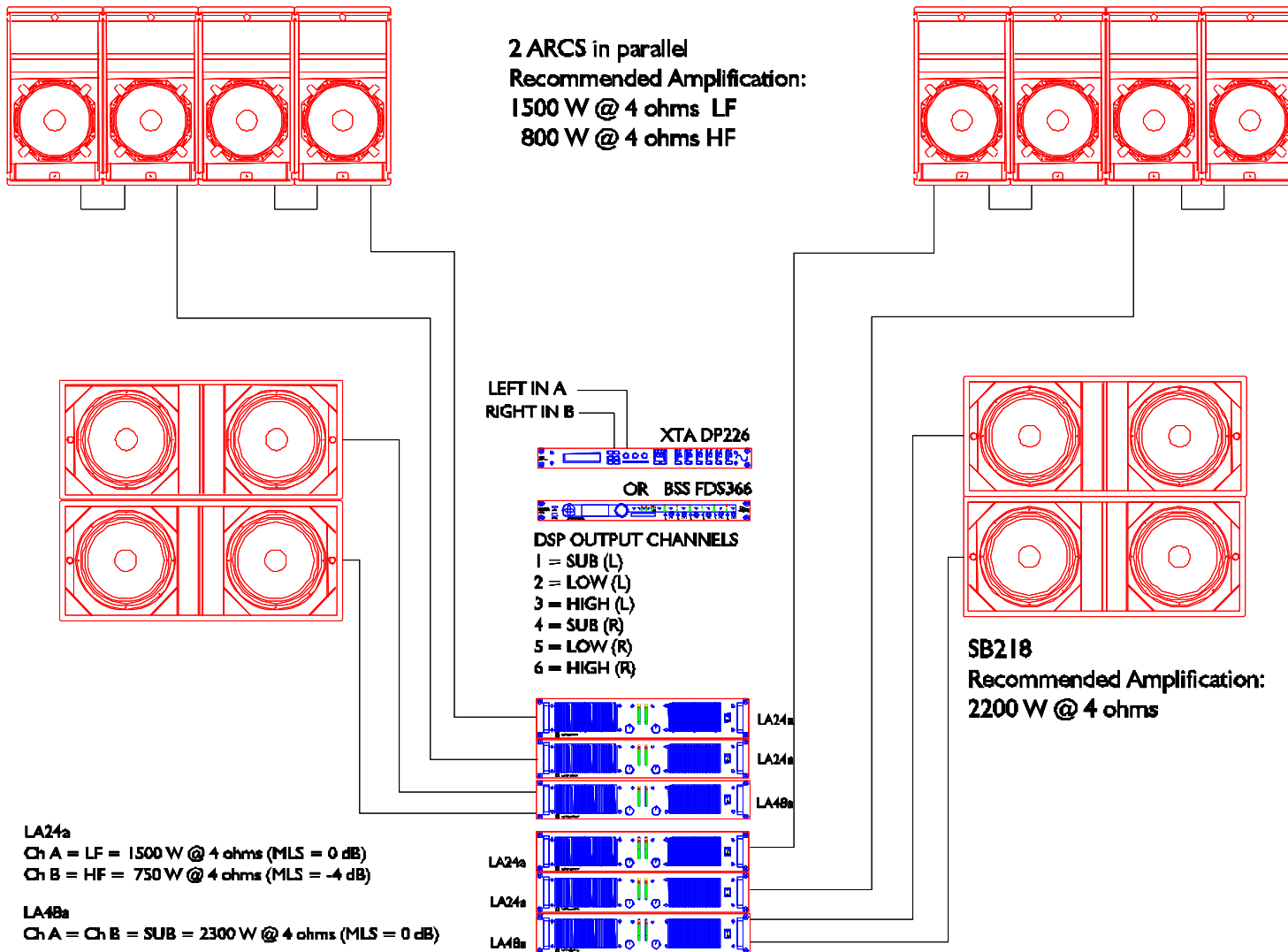

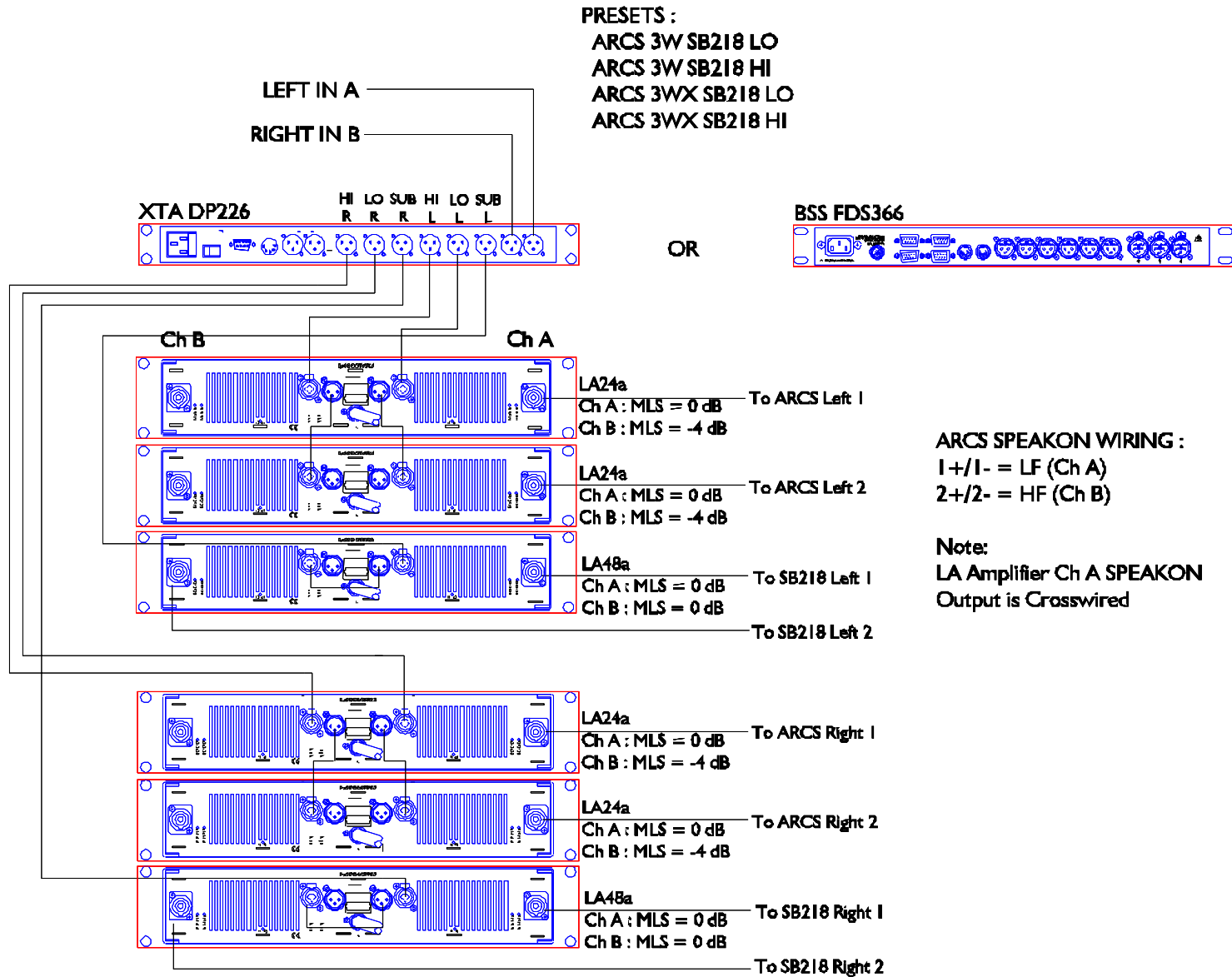

Figure 8b : ARCS System Cabling Details

1.2 ARCS SPECIFICATIONS

ARCS is a 22.5° trapezoidal enclosure designed for tightly-wrapped, fan-shaped horizontal or vertical arraying. Internal components include a weather resistant 15" loudspeaker (3" voice coil) plus a 1.4" exit (3" voice coil), titanium diaphragm high frequency compression driver. The 15" loudspeaker is direct-radiating, bass reflex loaded, while the compression driver is loaded by a custom DOSC waveguide that generates a pre-curved, rectangular wavefront according to Wavefront Sculpture Technology criteria. The exit of the DOSC waveguide is then loaded by a cylindrical lens that provides an asymmetrical coverage angle of +40°, -20°. The HF DOSC waveguide itself is constructed of foam-filled, injection-molded polyurethane and is acoustically resonant-free.

The ARCS enclosure is constructed of 18 mm Baltic birch plywood and all joints are rabbeted, screwed and glued. The ARCPLA transport dolly is of the same construction and is contoured to secure and protect ARCS during transportation. The structured, high-resiliency maroon-gray paint employed for the finish of ARCS provides excellent scratch resistance for a long-lasting appearance (touchup paint is available for maintenance purposes).

Internal steel bracing guarantees both flying security and long-term reliability of the cabinets under the most demanding of touring conditions. Coupling rails are bolted to internal bracing and are vertically connected to each other by internal steel bars. Two recessed handles are fitted on the top and bottom of the enclosure to facilitate handling.

A black, powder-coated 1.5 mm (0.06 in) thick steel grille protects the speakers. The grille is covered with open cell, acoustically-transparent foam. The L-ACOUSTICS logo on the front of the grille indicates the location of the 15" loudspeaker provided that the grille is installed in its normal orientation (i.e, rear Speakon connector jack plate towards the top, front logo towards the bottom as a reference).

All speaker components are installed in the enclosure using industrial strength screws and "Big Head" type nuts (allowing repeated mount/dismount of components without the problems of traditional "T" nut spinning). All fasteners and external components are either stainless steel or treated against corrosion.

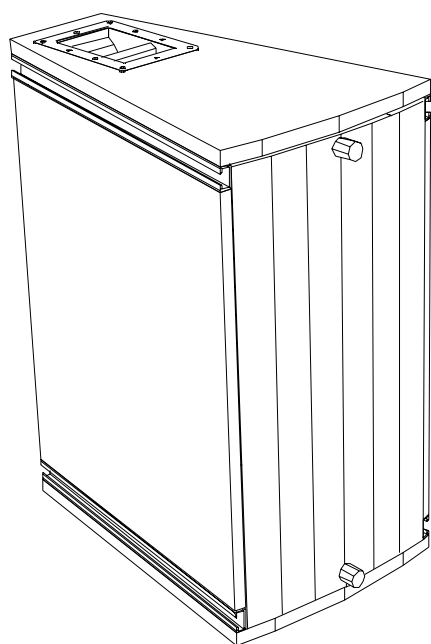

Dimensions:
Height x Front Width x Rear Width x Depth
820 x 440 x 190 x 652 mm
(32.3 x 17.3 x 7.5 x 25.7 in)

Net Weight:
57 kg (125.7 lbs)

Directivity:
22.5 degrees horizontal
+40, -20 degrees vertical

Connectors:
2 x 4-pin Neutrik NL4 Speakon

Figure 9: ARCS Enclosure

1.3 ARCS ACCESSORIES

ARCPLA

Front-mounted dolly for transportation and protection of the enclosure during transit (not necessary for fixed installations, but recommended for touring). ARCPLA is attached by mating the two positioning studs on the front baffle of the ARCS enclosure with the corresponding holes of the ARCPLA then locking the dolly to the enclosure using two O-ring snap-pins.

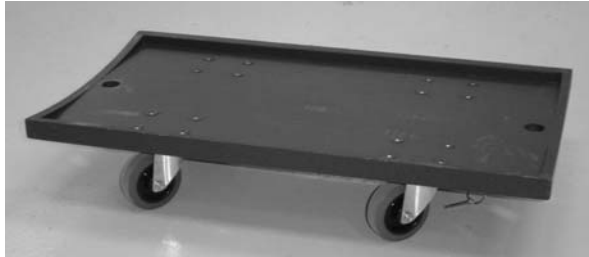

Figure 10: ARCPLA

ARCSCOV

Protective cover for transportation purposes. Constructed of rugged cordura material and padded for extra protection. Covers fold down flat for storage when not being using and feature strategically-located flaps and holes for convenient handling and testing purposes.



Figure 11: ARCSCOV

1.4 ARCS RIGGING COMPONENTS

ARCOUPL

Aluminum coupling bar designed to mechanically connect adjacent ARCS enclosures when arraying. The male connecting bar slides into the two female rails on adjacent ARCS to provide a tight mechanical connection between the enclosures. Two ARCOUPL are required for connecting two enclosures (one top, one bottom). ARCOUPL bars, once installed, are locked in place using two shackles on each end in order to prevent front to rear displacement.

Note: Only one shackle needs to be removed for assembly and disassembly operations – typically, the front shackle is removed since it is easier to access.

Note: ARCOUPL bars should be used for all stacked installations to provide improved physical stability.

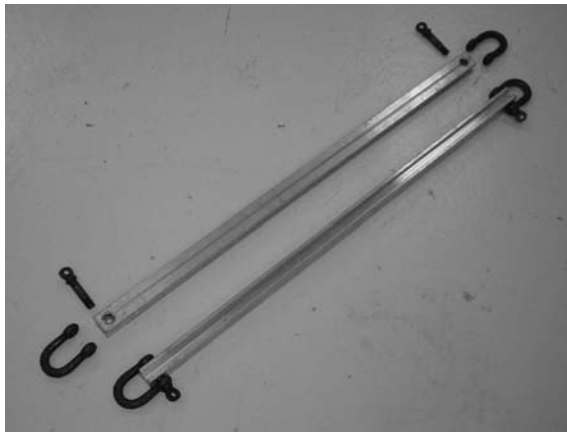
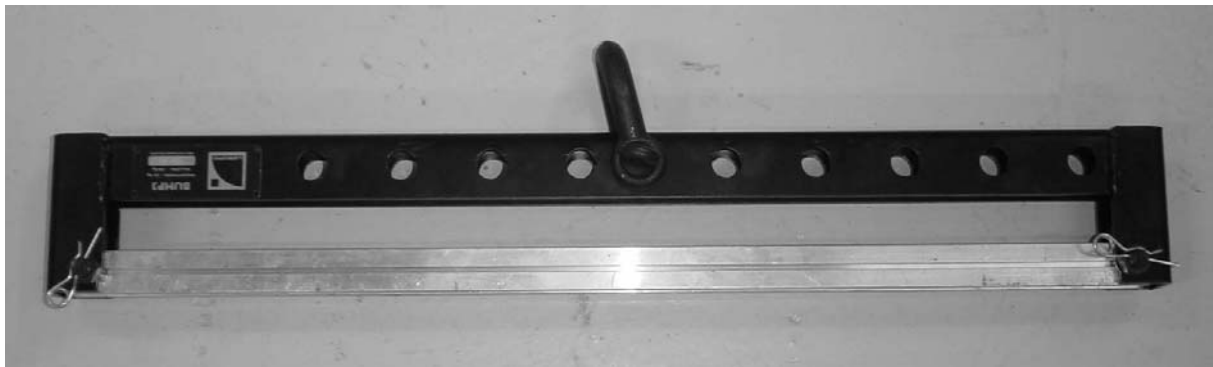

Figure 12: ARCOUPL

BUMP 3, LIFTBAR

Additional rigging elements used to fly an ARCS array. BUMP3 is assembled using locking nuts (with cotter pin safeties) and a standard ARCOUPL bar. A shackle is then attached to BUMP3 and used as a rigging point for the entire assembly (i.e., single point hang). Ten pick point holes are available on BUMP3, and the pick point is selected according to the center of gravity for the array in order to provide the desired overall tilt angle. Only one BUMP3 is required for flying an even number of enclosures (up to 4), whereas two BUMP3 and one LIFTBAR are required for flying an odd number or for more than 4 enclosures (up to 8). For larger configurations where ARCS is flown in the normal (vertical) orientation, there should be no more than 4 ARCS enclosures (vertically or horizontally) supported by a single BUMP3.

The rigging reference chart in Chapter 5 provides a table of array tilt angles for various BUMP3 and LIFTBAR pick point combinations.



BUMP3



LIFTBAR

Figure 13: BUMP3, LIFTBAR Rigging Accessories

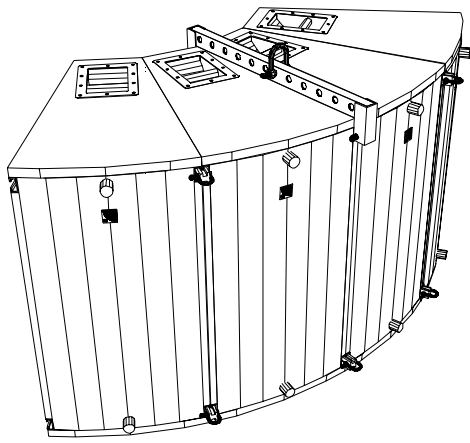

4 Element Arcs Array
(1 x BUMP3 required)

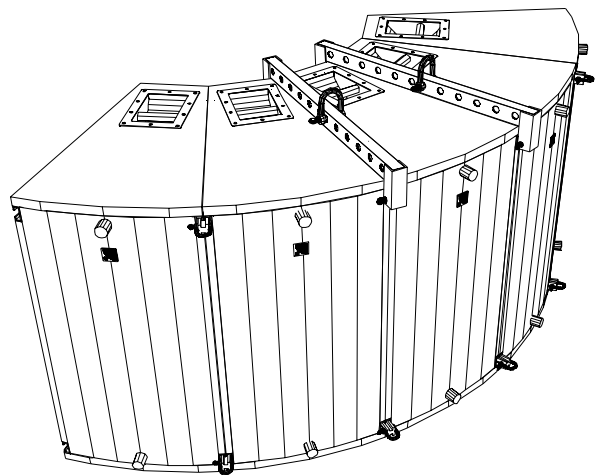

5 Element Arcs Array
(2 x BUMP3, 1 x LIFTBAR required)

Figure 14: Examples of BUMP3 Requirements for 4 and 5 Element ARCS Arrays

ARCBUMP

ARCBUMP is a rigging bumper that allows ARCS enclosures to be flown in the horizontal orientation (with DOSC waveguides vertically-oriented). For rigging up to 3 ARCS enclosures, single point hangs can be performed using the rigging points available on the central spreader bar section of ARCBUMP. For flying 4 ARCS enclosures horizontally, a bridled hang should be performed using the exterior points on the sides of the ARCBUMP frame. Safety steels must be employed for all flown horizontal applications. The safety steels are attached between all front and rear ARCOUPL attachment shackles, including the ARCOUPL bars that are used to attach ARCBUMP.

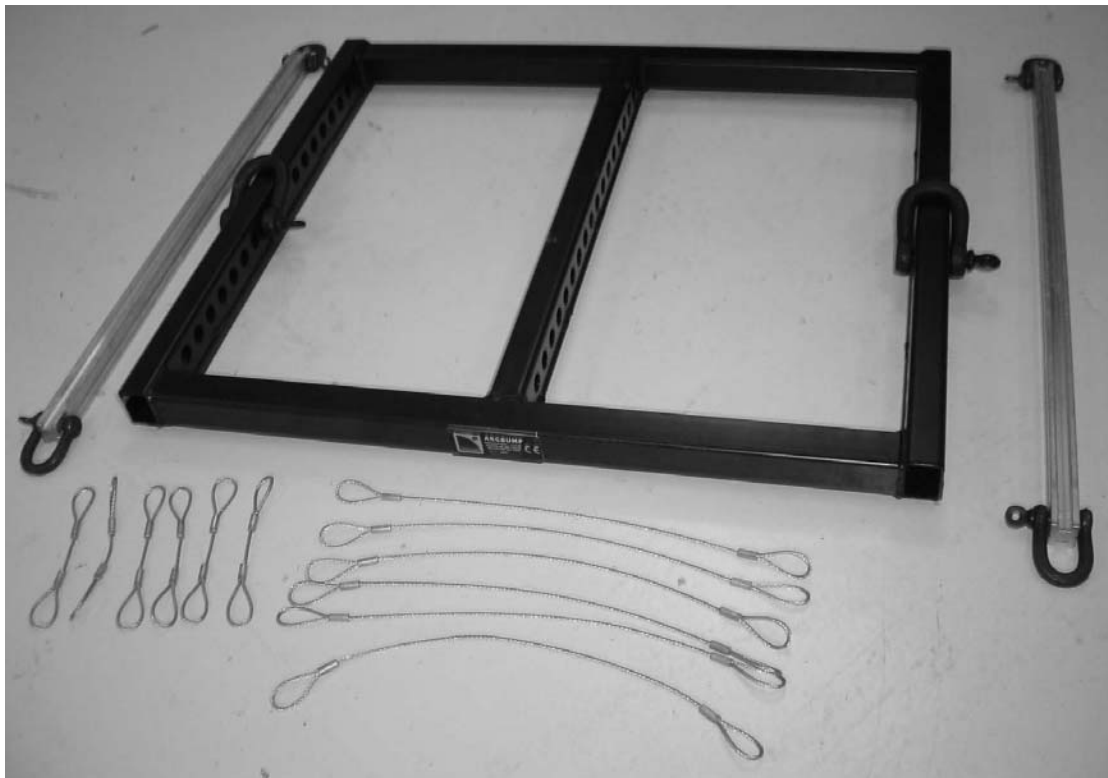

Figure 15: ARCBUMP

ARCSTRAP

ARCSTRAP is a vertical linking element used for flying double row ARCS configurations. The main U-channel section is used to physically link ARCOUPL bars (front and rear) between the top row of ARCS enclosures (bottom ARCOUPL bars) and bottom row ARCS enclosures (top ARCOUPL bars). Locking nuts with cotter pin safeties are then used to secure ARCSTRAP.

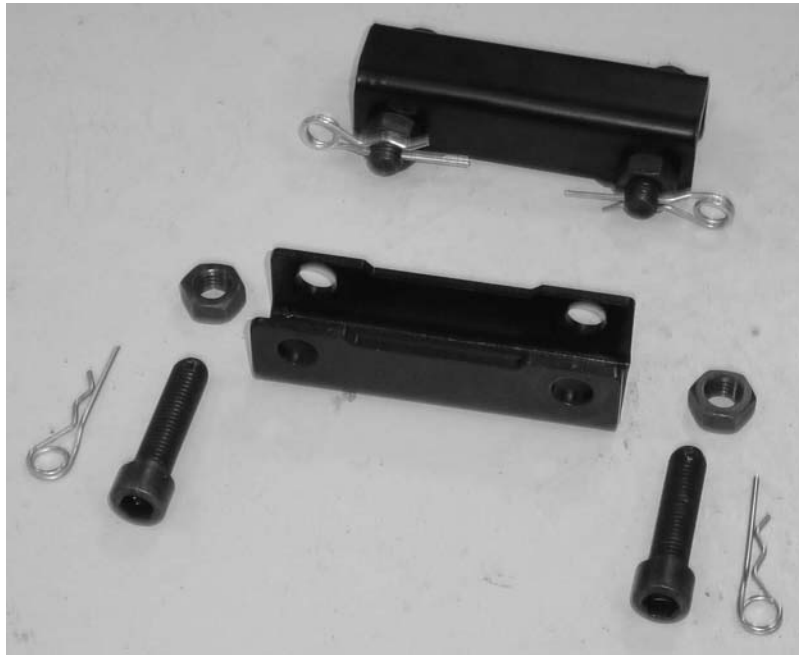

Figure 16: ARCSTRAP

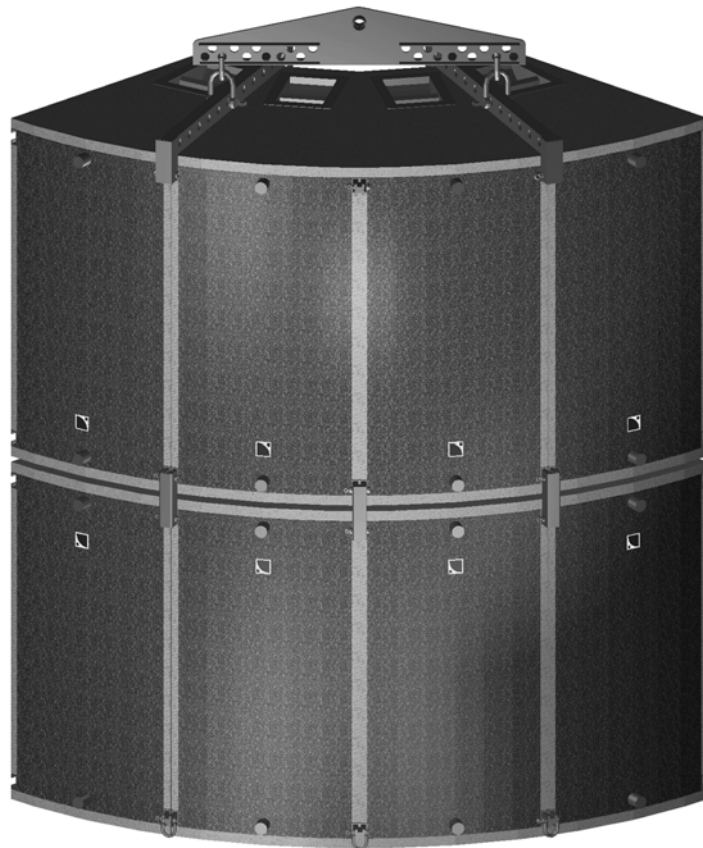

Figure 17: Example of ARCSTRAP, BUMP3, LIFTBAR Requirements for a 2 row x 4 element ARCS Array

2. POWERING ARCS

It is important that power amplifiers with sufficient power are used to power ARCS since headroom is much less likely to damage loudspeaker components than amplifier clipping. Apart from normal standards regarding construction, protection, cooling and damping factor that are expected of any professional sound reinforcement amplifier, the ARCS system has been calibrated to be used with amplifiers with the following specifications:

GAIN STRUCTURE

All amplifiers should have 32 dB gain for all sections (sub, low and high). The limiter thresholds and output channel gains of OEM digital crossover presets have been adjusted to be used with amplifiers having 32 dB gain.

LIMITERS

Peak limiters on all amplifier outputs with soft clipping characteristics; attack time less than 3 msec.

COOLING

Temperature speed-controlled fan recommended

POWER OUTPUT

Minimum and maximum power handling ratings for ARCS are as follows:

LF Section: 54 volts long term rms (pink noise with 6 dB crest factor)
375 Watts (rms), 1500 Watts (peak) at 8 ohms

HF Section: 29 volts long term rms (pink noise with 6 dB crest factor)
100 Watts (rms), 400 Watts (peak) at 8 ohms

In practice, L-ACOUSTICS specifies power amplifiers with power output equivalent to twice the RMS power handling for the low section and equivalent to the peak power handling for the high section. These requirements typically allow the same amplifier to be used for both LF and HF sections. For the high section, since the drive level is attenuated relative to the low section by up to 10 dB at the crossover to compensate for component efficiency differences, the same amplifier can be used since full continuous power is never delivered to the high section (i.e., due to the attenuation). Consequently, the extra available power translates to headroom for improved high frequency transient response.

Table 1 gives a summary of rms and peak power handling along with recommended amplifier output power specifications for 1, 2 or 3 ARCS in parallel.

Table 1: Load and Power Ratings for ARCS

| SECTION | ONE ARCS | | | | TWO ARCS | | | | THREE ARCS | | | |
|---------|----------|-----|------|-------|----------|-----|------|-------|------------|------|------|-------|
| | LOAD | RMS | PEAK | REC'D | LOAD | RMS | PEAK | REC'D | LOAD | RMS | PEAK | REC'D |
| LOW | 8 | 375 | 1500 | 750 | 4 | 750 | 3000 | 1500 | 2.7 | 1125 | 4500 | 2250 |
| HIGH | 8 | 100 | 400 | 400 | 4 | 200 | 800 | 800 | 2.7 | 300 | 1200 | 1200 |

For amplifying **2 ARCS in parallel**, the recommended amplifier specifications are:

- * LOW Amplifier Output Power: 1500 W into 4 ohms
- * HIGH Amplifier Output Power: 800 W into 4 ohms

For amplifying **3 ARCS in parallel**, the recommended amplifier specifications are:

- * LOW Amplifier Output Power: 2250 W into 2.7 ohms
- * HIGH Amplifier Output Power: 1200 W into 2.7 ohms

From Table 2 below it is seen that the L-ACOUSTICS LA24a is suitable powering up to 2 ARCS in parallel while the L-ACOUSTICS LA48a can be used for powering 3 ARCS in parallel. Alternatively, for operating 3 ARCS in parallel, the LA24a can be used to power the HI section while the LA48a is used for the LOW section.

Note: For more secure HF section operation, MLS switches should be set as follows in order to provide a better power match for the ARCS HF section:

LA24a ARCS HI Section: MLS = -4 dB
 LA48a ARCS HI Section: MLS = -5 dB

Table 2a: Recommended Power Amplification and MLS switch settings for ARCS low section

| ARCS LOW SECTION | | AMPLIFIER OUTPUT POWER | |
|------------------|----------------|------------------------------|-------------------------------|
| REC'D POWER | | (MLS SETTING) | |
| LOAD (ohms) | REC'D POWER | LA 24a | LA 48a |
| 2 | 3000 | 1700 do not use | 2900 (0 dB) |
| 2.7 | 2250 | 1635 do not use | 2700 (0 dB) |
| 4 | 1500 | 1500 (0 dB) | 1600 (-2 dB) |
| 8 | 750 | 1100 (0 dB) | 820 (-2 dB) |

Table 2b: Recommended Power Amplification and MLS switch settings for ARCS high section

| ARCS HI SECTION | | AMPLIFIER OUTPUT POWER | | |
|-----------------|----------------|-----------------------------|-------------------------------|-------------------------------|
| REC'D POWER | | (MLS SETTING) | | |
| LOAD (ohms) | REC'D POWER | LA 17a | LA 24a | LA 48a |
| 2 | 1600 | 1200 do not use | 1550 (-2 dB) | 1660 (-5 dB) |
| 2.7 | 1200 | 1080 do not use | 1180 (-4 dB) | 1380 (-5 dB) |
| 4 | 800 | 840 (0 dB) | 750 (-4 dB) | 830 (-5 dB) |
| 8 | 400 | 430 (0 dB) | 400 (-4 dB) | 430 (-5 dB) |

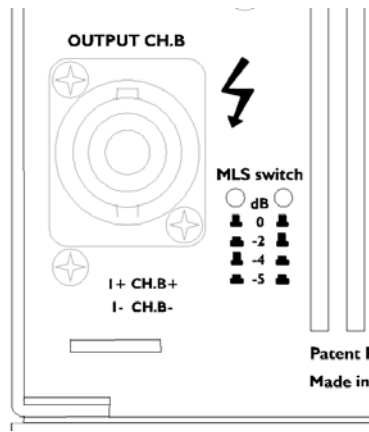

Figure 18: MLS switches on the rear panel of LA24a and LA48a amplifiers

Table 3: L-ACOUSTICS LA24a and LA48a Power Amplifier Specifications



L-ACOUSTICS LA 24a POWER MATRIX

| LOAD | CONFIGURATION | MLS SWITCH SETTING | | | |
|----------|--------------------|--------------------|-------|-------|------|
| | | -5 dB | -4 dB | -2 dB | 0 dB |
| 16 ohms | Stereo (2 channel) | 160 | 200 | 340 | 520 |
| 8 ohms | Stereo (2 channel) | 300 | 400 | 700 | 1100 |
| 4 ohms | Stereo (2 channel) | 600 | 750 | 1300 | 1500 |
| 2.7 ohms | Stereo (2 channel) | 1000 | 1180 | 1465 | 1635 |
| 2 ohms | Stereo (2 channel) | 1200 | 1400 | 1550 | 1700 |



L-ACOUSTICS LA 48a POWER MATRIX

| LOAD | CONFIGURATION | MLS SWITCH SETTING | | | |
|----------|--------------------|--------------------|-------|-------|------|
| | | -5 dB | -4 dB | -2 dB | 0 dB |
| 16 ohms | Stereo (2 channel) | 220 | 260 | 410 | 650 |
| 8 ohms | Stereo (2 channel) | 430 | 520 | 820 | 1300 |
| 4 ohms | Stereo (2 channel) | 830 | 1000 | 1600 | 2300 |
| 2.7 ohms | Stereo (2 channel) | 1380 | 1665 | 2130 | 2700 |
| 2 ohms | Stereo (2 channel) | 1660 | 2000 | 2400 | 2900 |

2.1 CONNECTORS AND CABLES

ARCS is supplied with dual NL4 Speakon connectors. The two Speakon connectors are internally wired in parallel allowing for loop through connection and parallel operation of 2-3 ARCS enclosures. Speakon connectors are wired as follows:

| | | |
|-----|---|------|
| 1 + | = | LF + |
| 1 - | = | LF - |
| 2 + | = | HF + |
| 2 - | = | HF - |

In order to preserve high damping factor (essential to the sonic qualities of the system and to prevent overshoot of cone displacement which can result in mechanical damage), it is desirable to keep loudspeaker cables as short as possible and with a gauge offering low resistance per unit length. The following chart provides information regarding the minimum wire cross-section versus length:

Table 4: Maximum Recommended Length for Damping Factor > 20

| Cross Section Metric (mm ²) | Gauge Imperial | 8 ohms | | 4 ohms | |
|--|-------------------|--------|----------|--------|----------|
| | | Metric | Imperial | Metric | Imperial |
| 2.5 | 13 | 30 m | 100 ft | 15 m | 45 ft |
| 4 | 11 | 50 m | 150 ft | 25 m | 75 ft |
| 6 | 8 | 75 m | 225 ft | 37 m | 110 ft |
| 10 | 6 | 120 m | 360 ft | 60 m | 180 ft |

As standard, L-ACOUSTICS F-CABLE (SP7, SP25) and F-LINK CABLE (SP.7) loudspeaker cables are 4 conductor cables with 4 mm² conductor cross-section (11 gauge). The SP25 cable can therefore be used for 25 meter cable runs to power a 4 ohm load (2 ARCS in parallel) with a damping factor greater than 20.

3. ARCS CONTROL AND PROCESSING

A digital processor is specified for use with ARCS in order to provide the following functions: crossover filtering, component time alignment, corrective component equalization, system protection and system equalization. OEM factory presets are provided for a number of approved digital processors including: XTA DP224, XTA DP226, XTA DP6i, Lake Contour, BSS Soundweb, BSS FDS 366 Omnidrive Compact Plus, BSS FDS 334 Minidrive, and BSS FDS 336 Minidrive. All presets are distributed via PCMCIA card (except for BSS Soundweb, BSS Minidrive and Lake Contour) and can also be downloaded from the L-ACOUSTICS website (www.l-acoustics.com).

Since the XTA DP226 and BSS Minidrive 336 are 2 input by 6 output units, the DP224 and Minidrive 334 are 2 x 4, and the BSS 366 Omnidrive Compact Plus is 3 x 6, exact internal wiring of your FOH drive rack and digital processor channel assignments will vary depending on the selected processor and the application. Carefully consider your flexibility requirements before selecting the number and type of processor to specify.

NOTE: ALWAYS REFER TO THE PRESET DESCRIPTION SHEET FOR YOUR PROCESSOR WHEN SELECTING PRESETS AND CONFIGURING THE DRIVE RACK.

3.1 GENERAL DESCRIPTION OF ARCS PRESETS

The selection of one preset over another depends on many parameters including the array configuration, musical program and personal taste of the sound engineer. In general terms, "LO" presets are the "smoothest" while "HI" presets are "brighter" (LO and HI refer to differences in the amount of HF shelving equalization applied to the ARCS high frequency section).

Standard 3W presets utilize a complimentary 80 Hz crossover point for ARCS and its companion subwoofer and are recommended for closely coupled applications. Alternatively, when ARCS enclosures are flown and subwoofers are ground stacked, 3WX presets can be employed where an 80 Hz low pass filter is applied to the subwoofers and ARCS high pass filtering is set at 40 Hz.

3W or 3WX Presets are optimized for a standard 2:1 cabinet ratio of ARCS : SB218 or dV-SUB (for example, 2:1, 4:2, 8:4) and for a 1:1 ARCS:SB118 cabinet ratio.

Preset names and descriptions for XTA 224, 226, BSS 334, 336, 366 and Lake Contour processors are given below. Full details of channel assignments and user adjustable parameters are provided in the Preset Description sheets that are distributed with the preset PCMCIA cards or with the preset library files when downloaded from www.l-acoustics.com.

3.2 ARCS PRESET POLICY

ARCS presets are intended to be used as a reference for all ARCS users and according to L-ACOUSTICS company policy, key parameters are software-protected and preset data is not communicated in order to preserve quality control, confidentiality and to maintain the integrity of L-ACOUSTICS system presets as a consistent reference.

A lot of engineering and real world testing goes into determining optimum presets – detailed polar measurements and weighted spatial averaging are used to determine component equalization, crossover points and crossover filter slopes, for example. As a result, ARCS presets give the user an optimum starting point – system tuning should be done using output gain attenuation, accurate subwoofer time alignment and system equalization – not by altering crossover presets for the following reason:

Without proper instrumentation and spatial averaging, adjustments made at one location (e.g. the mix position) are not optimum at all other locations within the defined coverage pattern of the system. When made by ear, such adjustments can be misguided – the user may be in a local room mode (low frequency pressure maximum or minimum) and/or may be hearing a cancellation or addition due to crossover misalignment that sounds good at that specific location but what about all others? Meanwhile, the same result could have been achieved while preserving the power response of the system (and satisfaction of WST criteria) by using the correct crossover preset and a simple equalization cut or correct time alignment of subwoofers ...

The bottom line is that making sure ARCS is used properly is in everyone's best interest and it is up to the sound engineer operating the system to maintain quality control standards. Quality control starts with a good sound design concept, accurate installation, correct preset selection and a solid methodology for system tuning. Restricting access to presets is in no way meant to restrict the creative process – on the contrary, the overall systems approach is intended to enhance it by ensuring quality control and repeatability.

In practice, presets are distributed to end users via PCMCIA Card (except for BSS Minidrive, BSS Soundweb and Lake Contour). Presets and updates are available directly from L-ACOUSTICS headquarters in France, L-ACOUSTICS US, L-ACOUSTICS UK or your local distributor. Preset libraries and upgrades can also be downloaded from www.l-acoustics.com.

3.3 GUIDELINES REGARDING SYSTEM PROTECTION

As supplied by L-ACOUSTICS, limit thresholds for XTA and BSS Processors are initially set at +9, +8 and +2 dBu for the SB218 subwoofer, ARCS low and high channels, respectively.

For the SB218, the LA48a is an excellent power match and the +9 dBu limit threshold is matched to the input sensitivity of the L-ACOUSTICS LA 48a (+9.5 dBu) so that system protection is performed by a combination of the limiting circuits of both amplifier and digital signal processor.

For the ARCS low section, the +8 dBu limit threshold corresponds to 3 dBu above the RMS power handling of the low section (i.e., twice the rated RMS power handling) and is also matched to the input sensitivity of the L-ACOUSTICS LA 24a (+7.7 dBu) so that system protection is performed by a combination of the limiting circuits of both amplifier and the digital signal processor.

Note: L-ACOUSTICS recommends that LA24a and LA48a Clip Limiters are engaged (i.e., rear panel switch depressed to the ON position) for all applications at all times

For the ARCS high section, the +2 dBu limit threshold corresponds to 3 dBu higher than the RMS power handling of the high section and system protection is performed by the limiting circuitry of the digital signal processor. As described previously, additional protection can be obtained by using the following MLS switch settings for power matching of the amplifier output to the power handling capacity of the ARCS HI section:

LA24aARCS HI Section: MLS = -4 dB

LA48aARCS HI Section: MLS = -5 dB

Note: As standard, the ARCS HF limiter threshold is set to +2 dBu corresponding to twice the RMS power handling (200 W), i.e, the RMS power handling is 100 W, peak power handling is 400 W and assuming 32 dB amplifier gain, these power ratings correspond to limit thresholds of -1 dBu (100 W) and +5 dBu (400 W). Standard thresholds should be suitable for most applications however the following adjustments can be made depending on the program content:

- 1) classical music - lots of transients, low RMS signal content
increase standard HF limit threshold by 3 dBu to correspond to the peak power handling
(for example, ARCS HF limit threshold: +2 dBu -> +5 dBu)
- 2) rave/techno music - high RMS signal content, long duration
decrease standard HF limit threshold by 3 dBu to correspond to the RMS power handling
(for example, ARCS HF limit threshold: +2 dBu -> -1 dBu)

NOTE: Setting limit thresholds to the amplifier input sensitivity (or the rated power handling of the section being driven) is important since this calibrates the output meter display of the crossover to correspond to either the amplifier clip point or the rated power handling. This gives the system operator a direct visual indication as to how hard the system is being operated and how much headroom remains.

The L-ACOUSTICS LA48a is an excellent power match for the SB218 subwoofer or the ARCS LOW Section (3 enclosures in parallel) while the LA24a is an excellent power match for up to 2 ARCS in parallel. For either LA48a or LA24a amplifiers, the clip limiter is sonically very transparent and works by monitoring the output and comparing the distortion produced between the input and output of the amplifier. If the distortion exceeds 1% THD for any reason (voltage or current clipping), the limiter reduces the input signal proportionally (2 msec attack, 150 msec release). Under normal operation, clip limiting is inaudible and L-ACOUSTICS recommends leaving the Channel A and B clip limiters switched "on" (rear panel button depressed) at all times.

NOTE: The LA48a has a relatively low input sensitivity (9.5 dBu). This means that, in practice, it may be necessary to equally scale up the individual crossover channel output gains in order to have sufficient drive capability (for all OEM factory presets 3-way output gains are initially set at +3, 0, -8 for sub, low and high sections, respectively). It is better to use the output drive capability of the

processor DACs and analog output section rather than overdrive the input ADCs so do not be afraid to increase the channel output gains in order to achieve a comfortable gain structure (for example: +6, +3, -5 dB output gains for sub, low, high channels may be necessary if the LA48a is used). Whether this is required will also depend on how "hot or cold" the FOH mix engineer likes to run the console. When in doubt, disconnect all loudspeaker cables and run pink noise from the console at nominal level through the crossover to the power amplifiers and examine crossover input/output levels, crossover limiter indicators and amplifier clip indicators to verify system protection and gain structure.

3.4 ARCS PRESET LIBRARIES

As standard, ARCS 2-way presets are configured in stereo 3-way mode, i.e., channel A and B Low/High outputs are on output channels 2 / 3 and 5 / 6, respectively. This means that drive racks do not require recabling when changing between 2-way and 3-way presets. In addition, for these 2-way presets, channels 1 and 4 are unlocked and available for programming of passive fill loudspeakers, subwoofers or, alternatively, for monitoring input system equalization when using the SMAART or SPECTRAFOO measurement systems.

| DSP OUTPUT CHANNEL | 3W STEREO PRESET | 2W STEREO PRESET |
|--------------------|------------------|------------------|
| 1 | SUB(A) | |
| 2 | LO (A) | LO (A) |
| 3 | HI (A) | HI (A) |
| 4 | SUB (B) | |
| 5 | LO (B) | LO (B) |
| 6 | HI (B) | HI (B) |

Note: for BSS 366, 3 x 2-way presets are provided in memory locations 37-46. This channel configuration is recommended for Left/Centre/Right (LCR) applications.

Please refer to the appropriate Preset Description Sheet (excel .XLS files) to assist in selecting the appropriate preset and as a reference for configuring crossover output channels for your drive rack or signal distribution system.

Complete Preset Description Sheet excel files are available for download from www.l-acoustics.com along with preset library data. As a quick reference, Tables 5-10 give channel assignments for XTA DP226, DP224, BSS 334, BSS336, Lake Contour and BSS 366, respectively.



L-ACOUSTICS V7.2 PRESETS for XTA DP226

| PRESET NAME | PGM TYPE | MEM | OUT 1 (Source) | OUT 2 (Source) | OUT 3 (Source) | OUT 4 (Source) | OUT 5 (Source) | OUT 6 (Source) |
|--------------------|---------------------------|-----|----------------|-------------------|------------------|----------------|-------------------|------------------|
| ARCS 2W LO | 3-way stereo | 10 | FULL (A) | ARCS LOW (A) | ARCS HI (A) | FULL (B) | ARCS LOW (B) | ARCS HI (B) |
| ARCS 2W HI | 3-way stereo | 11 | FULL (A) | ARCS LOW (A) | ARCS HI (A) | FULL (B) | ARCS LOW (B) | ARCS HI (B) |
| ARCS 3W SB118 LO | 3-way stereo | 12 | SB118 (A) | ARCS LOW (A) | ARCS HI (A) | SB118 (B) | ARCS LOW (B) | ARCS HI (B) |
| ARCS 3W SB118 HI | 3-way stereo | 13 | SB118 (A) | ARCS LOW (A) | ARCS HI (A) | SB118 (B) | ARCS LOW (B) | ARCS HI (B) |
| ARCS 3WX SB118 LO | 3-way stereo | 14 | SB118 (A) | ARCS LOW (A) | ARCS HI (A) | SB118 (B) | ARCS LOW (B) | ARCS HI (B) |
| ARCS 3WX SB118 HI | 3-way stereo | 15 | SB118 (A) | ARCS LOW (A) | ARCS HI (A) | SB118 (B) | ARCS LOW (B) | ARCS HI (B) |
| ARCS 3W SB218 LO | 3-way stereo | 16 | SB218 (A) | ARCS LOW (A) | ARCS HI (A) | SB218 (B) | ARCS LOW (B) | ARCS HI (B) |
| ARCS 3W SB218 HI | 3-way stereo | 17 | SB218 (A) | ARCS LOW (A) | ARCS HI (A) | SB218 (B) | ARCS LOW (B) | ARCS HI (B) |
| ARCS 3WX SB218 LO | 3-way stereo | 18 | SB218 (A) | ARCS LOW (A) | ARCS HI (A) | SB218 (B) | ARCS LOW (B) | ARCS HI (B) |
| ARCS 3WX SB218 HI | 3-way stereo | 19 | SB218 (A) | ARCS LOW (A) | ARCS HI (A) | SB218 (B) | ARCS LOW (B) | ARCS HI (B) |
| ARCS 3W dV-SUB LO | 3-way stereo | 20 | dV-SUB (A) | ARCS LOW (A) | ARCS HI (A) | dV-SUB (B) | ARCS LOW (B) | ARCS HI (B) |
| ARCS 3W dV-SUB HI | 3-way stereo | 21 | dV-SUB (A) | ARCS LOW (A) | ARCS HI (A) | dV-SUB (B) | ARCS LOW (B) | ARCS HI (B) |
| ARCS 3WX dV-SUB LO | 3-way stereo | 22 | dV-SUB (A) | ARCS LOW (A) | ARCS HI (A) | dV-SUB (B) | ARCS LOW (B) | ARCS HI (B) |
| ARCS 3WX dV-SUB HI | 3-way stereo | 23 | dV-SUB (A) | ARCS LOW (A) | ARCS HI (A) | dV-SUB (B) | ARCS LOW (B) | ARCS HI (B) |
| 112XT 2W FILL | 3-way stereo | 24 | FULL (A) | 112XT LOW (A) | 112XT HI (A) | FULL (B) | 112XT LOW (B) | 112XT HI (B) |
| 112XT 2W FRONT | 3-way stereo | 25 | FULL (A) | 112XT LOW (A) | 112XT HI (A) | FULL (B) | 112XT LOW (B) | 112XT HI (B) |
| 112XT 2W MONITOR | 3-way stereo (not linked) | 26 | FULL (A) | 112XT LOW (A) | 112XT HI (A) | FULL (B) | 112XT LOW (B) | 112XT HI (B) |
| 112XT 3W SB118 | 3-way stereo | 27 | SB118 (A) | 112XT LOW (A) | 112XT HI (A) | SB118 (B) | 112XT LOW (B) | 112XT HI (B) |
| 112XT 3WX SB118 | 3-way stereo | 28 | SB118 (A) | 112XT LOW (A) | 112XT HI (A) | SB118 (B) | 112XT LOW (B) | 112XT HI (B) |
| 112XT 3W SB218 | 3-way stereo | 29 | SB218 (A) | 112XT LOW (A) | 112XT HI (A) | SB218 (B) | 112XT LOW (B) | 112XT HI (B) |
| 112XT 3WX SB218 | 3-way stereo | 30 | SB218 (A) | 112XT LOW (A) | 112XT HI (A) | SB218 (B) | 112XT LOW (B) | 112XT HI (B) |
| 112XT 3W dV-SUB | 3-way stereo | 31 | dV-SUB (A) | 112XT LOW (A) | 112XT HI (A) | dV-SUB (B) | 112XT LOW (B) | 112XT HI (B) |
| 112XT 3WX dV-SUB | 3-way stereo | 32 | dV-SUB (A) | 112XT LOW (A) | 112XT HI (A) | dV-SUB (B) | 112XT LOW (B) | 112XT HI (B) |
| 115XT 2W FILL | 3-way stereo | 33 | FULL (A) | 115XT LOW (A) | 115XT HI (A) | FULL (B) | 115XT LOW (B) | 115XT HI (B) |
| 115XT 2W FRONT | 3-way stereo | 34 | FULL (A) | 115XT LOW (A) | 115XT HI (A) | FULL (B) | 115XT LOW (B) | 115XT HI (B) |
| 115XT 2W MONITOR | 3-way stereo (not linked) | 35 | FULL (A) | 115XT LOW (A) | 115XT HI (A) | FULL (B) | 115XT LOW (B) | 115XT HI (B) |
| 115XT 3W SB118 | 3-way stereo | 36 | SB118 (A) | 115XT LOW (A) | 115XT HI (A) | SB118 (B) | 115XT LOW (B) | 115XT HI (B) |
| 115XT 3WX SB118 | 3-way stereo | 37 | SB118 (A) | 115XT LOW (A) | 115XT HI (A) | SB118 (B) | 115XT LOW (B) | 115XT HI (B) |
| 115XT 3W SB218 | 3-way stereo | 38 | SB218 (A) | 115XT LOW (A) | 115XT HI (A) | SB218 (B) | 115XT LOW (B) | 115XT HI (B) |
| 115XT 3WX SB218 | 3-way stereo | 39 | SB218 (A) | 115XT LOW (A) | 115XT HI (A) | SB218 (B) | 115XT LOW (B) | 115XT HI (B) |
| 115XT 3W dV-SUB | 3-way stereo | 40 | dV-SUB (A) | 115XT LOW (A) | 115XT HI (A) | dV-SUB (B) | 115XT LOW (B) | 115XT HI (B) |
| 115XT 3WX dV-SUB | 3-way stereo | 41 | dV-SUB (A) | 115XT LOW (A) | 115XT HI (A) | dV-SUB (B) | 115XT LOW (B) | 115XT HI (B) |
| HiQ 2W FILL | 3-way stereo | 42 | FULL (A) | 115XT HiQ LOW (A) | 115XT HiQ HI (A) | FULL (B) | 115XT HiQ LOW (B) | 115XT HiQ HI (B) |
| HiQ 2W FRONT | 3-way stereo | 43 | FULL (A) | 115XT HiQ LOW (A) | 115XT HiQ HI (A) | FULL (B) | 115XT HiQ LOW (B) | 115XT HiQ HI (B) |
| HiQ 2W MONITOR | 3-way stereo (not linked) | 44 | FULL (A) | 115XT HiQ LOW (A) | 115XT HiQ HI (A) | FULL (B) | 115XT HiQ LOW (B) | 115XT HiQ HI (B) |
| 115FM 2W | 3-way stereo (not linked) | 45 | FULL (A) | 115FM LOW (A) | 115FM HI (A) | FULL (B) | 115FM LOW (B) | 115FM HI (B) |
| 115FM 2WX | 3-way stereo (not linked) | 46 | FULL (A) | 115FM LOW (A) | 115FM HI (A) | FULL (B) | 115FM LOW (B) | 115FM HI (B) |
| 115FM 3W SB118 | 3-way stereo | 47 | SB118 (A) | 115FM LOW (A) | 115FM HI (A) | SB118 (B) | 115FM LOW (B) | 115FM HI (B) |
| 115FM 3W SB218 | 3-way stereo | 48 | SB218 (A) | 115FM LOW (A) | 115FM HI (A) | SB218 (B) | 115FM LOW (B) | 115FM HI (B) |
| 115FM 3W dV-SUB | 3-way stereo | 49 | dV-SUB (A) | 115FM LOW (A) | 115FM HI (A) | dV-SUB (B) | 115FM LOW (B) | 115FM HI (B) |

Table 5: XTA DP226 Presets



L-ACOUSTICS V7.2 PRESETS for XTA DP224

| PRESET NAME | PGM TYPE | MEM | OUT 1 (Source) | OUT 2 (Source) | OUT 3 (Source) | OUT 4 (Source) |
|--------------------|---------------------------|-----|-------------------|------------------|-------------------|------------------|
| ARCS 2W LO | 2-way stereo | 10 | ARCS LOW (A) | ARCS HI (A) | ARCS LOW (B) | ARCS HI (B) |
| ARCS 2W HI | 2-way stereo | 11 | ARCS LOW (A) | ARCS HI (A) | ARCS LOW (B) | ARCS HI (B) |
| ARCS 3W SB118 LO | 3-way (A) + I (B) | 12 | SB118 (A) | ARCS LOW (A) | ARCS HI (A) | SB118 (B) |
| ARCS 3W SB118 HI | 3-way (A) + I (B) | 13 | SB118 (A) | ARCS LOW (A) | ARCS HI (A) | SB118 (B) |
| ARCS 3WX SB118 LO | 3-way (A) + I (B) | 14 | SB118 (A) | ARCS LOW (A) | ARCS HI (A) | SB118 (B) |
| ARCS 3WX SB118 HI | 3-way (A) + I (B) | 15 | SB118 (A) | ARCS LOW (A) | ARCS HI (A) | SB118 (B) |
| ARCS 3W SB218 LO | 3-way (A) + I (B) | 16 | SB218 (A) | ARCS LOW (A) | ARCS HI (A) | SB218 (B) |
| ARCS 3W SB218 HI | 3-way (A) + I (B) | 17 | SB218 (A) | ARCS LOW (A) | ARCS HI (A) | SB218 (B) |
| ARCS 3WX SB218 LO | 3-way (A) + I (B) | 18 | SB218 (A) | ARCS LOW (A) | ARCS HI (A) | SB218 (B) |
| ARCS 3WX SB218 HI | 3-way (A) + I (B) | 19 | SB218 (A) | ARCS LOW (A) | ARCS HI (A) | SB218 (B) |
| ARCS 3W dV-SUB LO | 3-way (A) + I (B) | 20 | dV-SUB (A) | ARCS LOW (A) | ARCS HI (A) | dV-SUB (B) |
| ARCS 3W dV-SUB HI | 3-way (A) + I (B) | 21 | dV-SUB (A) | ARCS LOW (A) | ARCS HI (A) | dV-SUB (B) |
| ARCS 3WX dV-SUB LO | 3-way (A) + I (B) | 22 | dV-SUB (A) | ARCS LOW (A) | ARCS HI (A) | dV-SUB (B) |
| ARCS 3WX dV-SUB HI | 3-way (A) + I (B) | 23 | dV-SUB (A) | ARCS LOW (A) | ARCS HI (A) | dV-SUB (B) |
| I12XT 2W FILL | 2-way stereo | 24 | I12XT LOW (A) | I12XT HI (A) | I12XT LOW (B) | I12XT HI (B) |
| I12XT 2W FRONT | 2-way stereo | 25 | I12XT LOW (A) | I12XT HI (A) | I12XT LOW (B) | I12XT HI (B) |
| I12XT 2W MONITOR | 2-way stereo (not linked) | 26 | I12XT LOW (A) | I12XT HI (A) | I12XT LOW (B) | I12XT HI (B) |
| I12XT 3W SB118 | 3-way (A) + I (B) | 27 | SB118 (A) | I12XT LOW (A) | I12XT HI (A) | SB118 (B) |
| I12XT 3WX SB118 | 3-way (A) + I (B) | 28 | SB118 (A) | I12XT LOW (A) | I12XT HI (A) | SB118 (B) |
| I12XT 3W SB218 | 3-way (A) + I (B) | 29 | SB218 (A) | I12XT LOW (A) | I12XT HI (A) | SB218 (B) |
| I12XT 3WX SB218 | 3-way (A) + I (B) | 30 | SB218 (A) | I12XT LOW (A) | I12XT HI (A) | SB218 (B) |
| I12XT 3W dV-SUB | 3-way (A) + I (B) | 31 | dV-SUB (A) | I12XT LOW (A) | I12XT HI (A) | dV-SUB (B) |
| I12XT 3WX dV-SUB | 3-way (A) + I (B) | 32 | dV-SUB (A) | I12XT LOW (A) | I12XT HI (A) | dV-SUB (B) |
| I15XT 2W FILL | 2-way stereo | 33 | I15XT LOW (A) | I15XT HI (A) | I15XT LOW (B) | I15XT HI (B) |
| I15XT 2W FRONT | 2-way stereo | 34 | I15XT LOW (A) | I15XT HI (A) | I15XT LOW (B) | I15XT HI (B) |
| I15XT 2W MONITOR | 2-way stereo (not linked) | 35 | I15XT LOW (A) | I15XT HI (A) | I15XT LOW (B) | I15XT HI (B) |
| I15XT 3W SB118 | 3-way (A) + I (B) | 36 | SB118 (A) | I15XT LOW (A) | I15XT HI (A) | SB118 (B) |
| I15XT 3WX SB118 | 3-way (A) + I (B) | 37 | SB118 (A) | I15XT LOW (A) | I15XT HI (A) | SB118 (B) |
| I15XT 3W SB218 | 3-way (A) + I (B) | 38 | SB218 (A) | I15XT LOW (A) | I15XT HI (A) | SB218 (B) |
| I15XT 3WX SB218 | 3-way (A) + I (B) | 39 | SB218 (A) | I15XT LOW (A) | I15XT HI (A) | SB218 (B) |
| I15XT 3W dV-SUB | 3-way (A) + I (B) | 40 | dV-SUB (A) | I15XT LOW (A) | I15XT HI (A) | dV-SUB (B) |
| I15XT 3WX dV-SUB | 3-way (A) + I (B) | 41 | dV-SUB (A) | I15XT LOW (A) | I15XT HI (A) | dV-SUB (B) |
| HiQ 2W FILL | 2-way stereo | 42 | I15XT HiQ LOW (A) | I15XT HiQ HI (A) | I15XT HiQ LOW (B) | I15XT HiQ HI (B) |
| HiQ 2W FRONT | 2-way stereo | 43 | I15XT HiQ LOW (A) | I15XT HiQ HI (A) | I15XT HiQ LOW (B) | I15XT HiQ HI (B) |
| HiQ 2W MONITOR | 2-way stereo (not linked) | 44 | I15XT HiQ LOW (A) | I15XT HiQ HI (A) | I15XT HiQ LOW (B) | I15XT HiQ HI (B) |
| I15FM 2W | 2-way stereo (not linked) | 45 | 115FM LO (A) | 115FM HI (A) | 115FM LO (B) | 115FM HI (B) |
| I15FM 2WX | 2-way stereo (not linked) | 46 | 115FM LO (A) | 115FM HI (A) | 115FM LO (B) | 115FM HI (B) |
| I15FM 3W SB118 | 3-way (A) + I (B) | 47 | SB118 (A) | I15FM LOW (A) | I15FM HI (A) | SB118 (B) |
| I15FM 3W SB218 | 3-way (A) + I (B) | 48 | SB218 (A) | I15FM LOW (A) | I15FM HI (A) | SB218 (B) |
| I15FM 3W dV-SUB | 3-way (A) + I (B) | 49 | dV-SUB (A) | I15FM LOW (A) | I15FM HI (A) | dV-SUB (B) |

Table 6: XTA DP224 Presets



L-ACOUSTICS V7.2 PRESETS for BSS 334 MINIDRIVE

| PRESET NAME | PGM TYPE | MEM | OUT 1 (Source) | OUT 2 (Source) | OUT 3 (Source) | OUT 4 (Source) |
|-------------|---------------------------|-----|------------------|------------------|------------------|------------------|
| ARCS 2W LO | 2-way stereo | 1 | ARCS LO (A) | ARCS LO (B) | ARCS HI (A) | ARCS HI (B) |
| ARCS 2W HI | 2-way stereo | 2 | ARCS LO (A) | ARCS LO (B) | ARCS HI (A) | ARCS HI (B) |
| A 3W 118 LO | 3-way (A) + SUB (B) | 3 | SB118 (A) | ARCS LO (A) | ARCS HI (A) | SB118 (B) |
| A 3W 118 HI | 3-way (A) + SUB (B) | 4 | SB118 (A) | ARCS LO (A) | ARCS HI (A) | SB118 (B) |
| A 3WX 118 L | 3-way (A) + SUB (B) | 5 | SB118 (A) | ARCS LO (A) | ARCS HI (A) | SB118 (B) |
| A 3WX 118 H | 3-way (A) + SUB (B) | 6 | SB118 (A) | ARCS LO (A) | ARCS HI (A) | SB118 (B) |
| A 3W 218 LO | 3-way (A) + SUB (B) | 7 | SB218 (A) | ARCS LO (A) | ARCS HI (A) | SB218 (B) |
| A 3W 218 HI | 3-way (A) + SUB (B) | 8 | SB218 (A) | ARCS LO (A) | ARCS HI (A) | SB218 (B) |
| A 3WX 218 L | 3-way (A) + SUB (B) | 9 | SB218 (A) | ARCS LO (A) | ARCS HI (A) | SB218 (B) |
| A 3WX 218 H | 3-way (A) + SUB (B) | 10 | SB218 (A) | ARCS LO (A) | ARCS HI (A) | SB218 (B) |
| A 3W DVS LO | 3-way (A) + SUB (B) | 11 | dV-SUB (A) | ARCS LO (A) | ARCS HI (A) | dV-SUB (B) |
| A 3W DVS HI | 3-way (A) + SUB (B) | 12 | dV-SUB (A) | ARCS LO (A) | ARCS HI (A) | dV-SUB (B) |
| A 3WX DVS L | 3-way (A) + SUB (B) | 13 | dV-SUB (A) | ARCS LO (A) | ARCS HI (A) | dV-SUB (B) |
| A 3WX DVS H | 3-way (A) + SUB (B) | 14 | dV-SUB (A) | ARCS LO (A) | ARCS HI (A) | dV-SUB (B) |
| I12XT FIL | 2-way stereo | 15 | I12XT LO (A) | I12XT LO (B) | I12XT HI (A) | I12XT HI (B) |
| I12XT FOH | 2-way stereo | 16 | I12XT LO (A) | I12XT LO (B) | I12XT HI (A) | I12XT HI (B) |
| I12XT MON | 2-way stereo (not linked) | 17 | I12XT LO (A) | I12XT LO (B) | I12XT HI (A) | I12XT HI (B) |
| I12 SB115 | 3-way (A) + SUB (B) | 18 | SB115 (A) | I12XT LO (A) | I12XT HI (A) | SB115 (B) |
| I12 X 115 | 3-way (A) + SUB (B) | 19 | SB115 (A) | I12XT LO (A) | I12XT HI (A) | SB115 (B) |
| I12 SB118 | 3-way (A) + SUB (B) | 20 | SB118 (A) | I12XT LO (A) | I12XT HI (A) | SB118 (B) |
| I12 X 118 | 3-way (A) + SUB (B) | 21 | SB118 (A) | I12XT LO (A) | I12XT HI (A) | SB118 (B) |
| I12 SB218 | 3-way (A) + SUB (B) | 22 | SB218 (A) | I12XT LO (A) | I12XT HI (A) | SB218 (B) |
| I12 X 218 | 3-way (A) + SUB (B) | 23 | SB218 (A) | I12XT LO (A) | I12XT HI (A) | SB218 (B) |
| I12 DVSUB | 3-way (A) + SUB (B) | 24 | dV-SUB (A) | I12XT LO (A) | I12XT HI (A) | dV-SUB (B) |
| I12 X dVS | 3-way (A) + SUB (B) | 25 | dV-SUB (A) | I12XT LO (A) | I12XT HI (A) | dV-SUB (B) |
| I15XT FIL | 2-way stereo | 26 | I15XT LO (A) | I15XT LO (B) | I15XT HI (A) | I15XT HI (B) |
| I15XT FOH | 2-way stereo | 27 | I15XT LO (A) | I15XT LO (B) | I15XT HI (A) | I15XT HI (B) |
| I15XT MON | 2-way stereo (not linked) | 28 | I15XT LO (A) | I15XT LO (B) | I15XT HI (A) | I15XT HI (B) |
| I15 SB115 | 3-way (A) + SUB (B) | 29 | SB115 (A) | I15XT LO (A) | I15XT HI (A) | SB115 (B) |
| I15 X 115 | 3-way (A) + SUB (B) | 30 | SB115 (A) | I15XT LO (A) | I15XT HI (A) | SB115 (B) |
| I15 SB118 | 3-way (A) + SUB (B) | 31 | SB118 (A) | I15XT LO (A) | I15XT HI (A) | SB118 (B) |
| I15 X 118 | 3-way (A) + SUB (B) | 32 | SB118 (A) | I15XT LO (A) | I15XT HI (A) | SB118 (B) |
| I15 SB218 | 3-way (A) + SUB (B) | 33 | SB218 (A) | I15XT LO (A) | I15XT HI (A) | SB218 (B) |
| I15 X 218 | 3-way (A) + SUB (B) | 34 | SB218 (A) | I15XT LO (A) | I15XT HI (A) | SB218 (B) |
| I15 DVSUB | 3-way (A) + SUB (B) | 35 | dV-SUB (A) | I15XT LO (A) | I15XT HI (A) | dV-SUB (B) |
| I15 X dVS | 3-way (A) + SUB (B) | 36 | dV-SUB (A) | I15XT LO (A) | I15XT HI (A) | dV-SUB (B) |
| HiQ FILL | 2-way stereo | 37 | I15XT HiQ LO (A) | I15XT HiQ LO (B) | I15XT HiQ HI (A) | I15XT HiQ HI (B) |
| HiQ FOH | 2-way stereo | 38 | I15XT HiQ LO (A) | I15XT HiQ LO (B) | I15XT HiQ HI (A) | I15XT HiQ HI (B) |
| HiQ MON | 2-way stereo (not linked) | 39 | I15XT HiQ LO (A) | I15XT HiQ LO (B) | I15XT HiQ HI (A) | I15XT HiQ HI (B) |
| I15FM 2W | 2-way stereo (not linked) | 40 | I15FM LO (A) | I15FM LO (B) | I15FM HI (A) | I15FM HI (B) |
| I15FM 2WX | 2-way stereo (not linked) | 41 | I15FM LO (A) | I15FM LO (B) | I15FM HI (A) | I15FM HI (B) |
| FM SB115 | 3-way (A) + SUB (B) | 42 | SB115 (A) | I15FM LO (A) | I15FM HI (A) | SB115 (B) |
| FM SB118 | 3-way (A) + SUB (B) | 43 | SB118 (A) | I15FM LO (A) | I15FM HI (A) | SB118 (B) |
| FM SB218 | 3-way (A) + SUB (B) | 44 | SB218 (A) | I15FM LO (A) | I15FM HI (A) | SB218 (B) |
| FM dVSUB | 3-way (A) + SUB (B) | 45 | dV-SUB (A) | I15FM LO (A) | I15FM HI (A) | dV-SUB (B) |

Table 7: BSS 334 Minidrive Presets



L-ACOUSTICS V7.2 PRESETS for BSS 336 MINIDRIVE

| PRESET NAME | PGM TYPE | Mem | OUT 1 (Source) | OUT 2 (Source) | OUT 3 (Source) | OUT 4 (Source) | OUT 5 (Source) | OUT 6 (Source) |
|-------------|-----------|-----|----------------|----------------|-------------------|-------------------|------------------|------------------|
| ARCS 2W LO | 3(A)+3(B) | 1 | FULL (A) | FULL (B) | ARCS LOW (A) | ARCS LOW (B) | ARCS HI (A) | ARCS HI (B) |
| ARCS 2W HI | 3(A)+3(B) | 2 | FULL (A) | FULL (B) | ARCS LOW (A) | ARCS LOW (B) | ARCS HI (A) | ARCS HI (B) |
| A 3W 118 LO | 3(A)+3(B) | 3 | SB118 (A) | SB118 (B) | ARCS LOW (A) | ARCS LOW (B) | ARCS HI (A) | ARCS HI (B) |
| A 3W 118 HI | 3(A)+3(B) | 4 | SB118 (A) | SB118 (B) | ARCS LOW (A) | ARCS LOW (B) | ARCS HI (A) | ARCS HI (B) |
| A 3WX 118 L | 3(A)+3(B) | 5 | SB118 (A) | SB118 (B) | ARCS LOW (A) | ARCS LOW (B) | ARCS HI (A) | ARCS HI (B) |
| A 3WX 118 H | 3(A)+3(B) | 6 | SB118 (A) | SB118 (B) | ARCS LOW (A) | ARCS LOW (B) | ARCS HI (A) | ARCS HI (B) |
| A 3W 218 LO | 3(A)+3(B) | 7 | SB218 (A) | SB218 (B) | ARCS LOW (A) | ARCS LOW (B) | ARCS HI (A) | ARCS HI (B) |
| A 3W 218 HI | 3(A)+3(B) | 8 | SB218 (A) | SB218 (B) | ARCS LOW (A) | ARCS LOW (B) | ARCS HI (A) | ARCS HI (B) |
| A 3WX 218 L | 3(A)+3(B) | 9 | SB218 (A) | SB218 (B) | ARCS LOW (A) | ARCS LOW (B) | ARCS HI (A) | ARCS HI (B) |
| A 3WX 218 H | 3(A)+3(B) | 10 | SB218 (A) | SB218 (B) | ARCS LOW (A) | ARCS LOW (B) | ARCS HI (A) | ARCS HI (B) |
| A 3W DV5 LO | 3(A)+3(B) | 11 | dV-SUB (A) | dV-SUB (B) | ARCS LOW (A) | ARCS LOW (B) | ARCS HI (A) | ARCS HI (B) |
| A 3W DV5 HI | 3(A)+3(B) | 12 | dV-SUB (A) | dV-SUB (B) | ARCS LOW (A) | ARCS LOW (B) | ARCS HI (A) | ARCS HI (B) |
| A 3WX DV5 L | 3(A)+3(B) | 13 | dV-SUB (A) | dV-SUB (B) | ARCS LOW (A) | ARCS LOW (B) | ARCS HI (A) | ARCS HI (B) |
| A 3WX DV5 H | 3(A)+3(B) | 14 | dV-SUB (A) | dV-SUB (B) | ARCS LOW (A) | ARCS LOW (B) | ARCS HI (A) | ARCS HI (B) |
| 112XT FIL | 3(A)+3(B) | 15 | FULL (A) | FULL (B) | 112XT LOW (A) | 112XT LOW (B) | 112XT HI (A) | 112XT HI (B) |
| 112XT FOH | 3(A)+3(B) | 16 | FULL (A) | FULL (B) | 112XT LOW (A) | 112XT LOW (B) | 112XT HI (A) | 112XT HI (B) |
| 112XT MON | 3(A)+3(B) | 17 | FULL (A) | FULL (B) | 112XT LOW (A) | 112XT LOW (B) | 112XT HI (A) | 112XT HI (B) |
| 112 SB115 | 3(A)+3(B) | 18 | SB115 (A) | SB115 (B) | 112XT LOW (A) | 112XT LOW (B) | 112XT HI (A) | 112XT HI (B) |
| 112 X 115 | 3(A)+3(B) | 19 | SB115 (A) | SB115 (B) | 112XT LOW (A) | 112XT LOW (B) | 112XT HI (A) | 112XT HI (B) |
| 112 SB118 | 3(A)+3(B) | 20 | SB118 (A) | SB118 (B) | 112XT LOW (A) | 112XT LOW (B) | 112XT HI (A) | 112XT HI (B) |
| 112 X 118 | 3(A)+3(B) | 21 | SB118 (A) | SB118 (B) | 112XT LOW (A) | 112XT LOW (B) | 112XT HI (A) | 112XT HI (B) |
| 112 SB218 | 3(A)+3(B) | 22 | SB218 (A) | SB218 (B) | 112XT LOW (A) | 112XT LOW (B) | 112XT HI (A) | 112XT HI (B) |
| 112 X 218 | 3(A)+3(B) | 23 | SB218 (A) | SB218 (B) | 112XT LOW (A) | 112XT LOW (B) | 112XT HI (A) | 112XT HI (B) |
| 112 DV5SUB | 3(A)+3(B) | 24 | dV-SUB (A) | dV-SUB (B) | 112XT LOW (A) | 112XT LOW (B) | 112XT HI (A) | 112XT HI (B) |
| 112 X dV5 | 3(A)+3(B) | 25 | dV-SUB (A) | dV-SUB (B) | 112XT LOW (A) | 112XT LOW (B) | 112XT HI (A) | 112XT HI (B) |
| 115XT FIL | 3(A)+3(B) | 26 | FULL (A) | FULL (B) | 115XT LOW (A) | 115XT LOW (B) | 115XT HI (A) | 115XT HI (B) |
| 115XT FOH | 3(A)+3(B) | 27 | FULL (A) | FULL (B) | 115XT LOW (A) | 115XT LOW (B) | 115XT HI (A) | 115XT HI (B) |
| 115XT MON | 3(A)+3(B) | 28 | FULL (A) | FULL (B) | 115XT LOW (A) | 115XT LOW (B) | 115XT HI (A) | 115XT HI (B) |
| 115 SB115 | 3(A)+3(B) | 29 | SB115 (A) | SB115 (B) | 115XT LOW (A) | 115XT LOW (B) | 115XT HI (A) | 115XT HI (B) |
| 115 X 115 | 3(A)+3(B) | 30 | SB115 (A) | SB115 (B) | 115XT LOW (A) | 115XT LOW (B) | 115XT HI (A) | 115XT HI (B) |
| 115 SB118 | 3(A)+3(B) | 31 | SB118 (A) | SB118 (B) | 115XT LOW (A) | 115XT LOW (B) | 115XT HI (A) | 115XT HI (B) |
| 115 X 118 | 3(A)+3(B) | 32 | SB118 (A) | SB118 (B) | 115XT LOW (A) | 115XT LOW (B) | 115XT HI (A) | 115XT HI (B) |
| 115 SB218 | 3(A)+3(B) | 33 | SB218 (A) | SB218 (B) | 115XT LOW (A) | 115XT LOW (B) | 115XT HI (A) | 115XT HI (B) |
| 115 X 218 | 3(A)+3(B) | 34 | SB218 (A) | SB218 (B) | 115XT LOW (A) | 115XT LOW (B) | 115XT HI (A) | 115XT HI (B) |
| 115 DV5SUB | 3(A)+3(B) | 35 | dV-SUB (A) | dV-SUB (B) | 115XT LOW (A) | 115XT LOW (B) | 115XT HI (A) | 115XT HI (B) |
| 115 X dV5 | 3(A)+3(B) | 36 | dV-SUB (A) | dV-SUB (B) | 115XT LOW (A) | 115XT LOW (B) | 115XT HI (A) | 115XT HI (B) |
| HiQ FILL | 3(A)+3(B) | 37 | FULL (A) | FULL (B) | 115XT HiQ LOW (A) | 115XT HiQ LOW (B) | 115XT HiQ HI (A) | 115XT HiQ HI (B) |
| HiQ FOH | 3(A)+3(B) | 38 | FULL (A) | FULL (B) | 115XT HiQ LOW (A) | 115XT HiQ LOW (B) | 115XT HiQ HI (A) | 115XT HiQ HI (B) |
| HiQ MON | 3(A)+3(B) | 39 | FULL (A) | FULL (B) | 115XT HiQ LOW (A) | 115XT HiQ LOW (B) | 115XT HiQ HI (A) | 115XT HiQ HI (B) |
| 115FM 2W | 3(A)+3(B) | 40 | FULL (A) | FULL (B) | 115FM LOW (A) | 115FM LOW (B) | 115FM HI (A) | 115FM HI (B) |
| 115FM 2WX | 3(A)+3(B) | 41 | FULL (A) | FULL (B) | 115FM LOW (A) | 115FM LOW (B) | 115FM HI (A) | 115FM HI (B) |
| FM SB115 | 3(A)+3(B) | 42 | SB115 (A) | SB115 (B) | 115FM LOW (A) | 115FM LOW (B) | 115FM HI (A) | 115FM HI (B) |
| FM SB118 | 3(A)+3(B) | 43 | SB118 (A) | SB118 (B) | 115FM LOW (A) | 115FM LOW (B) | 115FM HI (A) | 115FM HI (B) |
| FM SB218 | 3(A)+3(B) | 44 | SB218 (A) | SB218 (B) | 115FM LOW (A) | 115FM LOW (B) | 115FM HI (A) | 115FM HI (B) |
| FM dV5SUB | 3(A)+3(B) | 45 | dV-SUB (A) | dV-SUB (B) | 115FM LOW (A) | 115FM LOW (B) | 115FM HI (A) | 115FM HI (B) |

Table 8: BSS 336 Minidrive Presets



L-ACOUSTICS V7.1 PRESET MODULES for LAKE CONTOUR

| | OUT 1 (Source) | OUT 2 (Source) | OUT 3 (Source) | OUT 4 (Source) | OUT 5 (Source) | OUT 6 (Source) |
|---------------------------------|------------------|------------------|----------------|------------------|------------------|----------------|
| 2-WAY MODULES | | | | | | |
| ARCS 2W LO | ARCS LO (A) | ARCS HI (A) | FULL (A) | ARCS LO (B) | ARCS HI (B) | FULL (B) |
| ARCS 2W HI | ARCS LO (A) | ARCS HI (A) | FULL (A) | ARCS LO (B) | ARCS HI (B) | FULL (B) |
| 112XT FILL | 112XT LO (A) | 112XT HI (A) | FULL (A) | 112XT LO (B) | 112XT HI (B) | FULL (B) |
| 112XT FRONT | 112XT LO (A) | 112XT HI (A) | FULL (A) | 112XT LO (B) | 112XT HI (B) | FULL (B) |
| 112XT MONITOR | 112XT LO (A) | 112XT HI (A) | FULL (A) | 112XT LO (B) | 112XT HI (B) | FULL (B) |
| 115XT FILL | 115XT LO (A) | 115XT HI (A) | FULL (A) | 115XT LO (B) | 115XT HI (B) | FULL (B) |
| 115XT FRONT | 115XT LO (A) | 115XT HI (A) | FULL (A) | 115XT LO (B) | 115XT HI (B) | FULL (B) |
| 115XT MONITOR | 115XT LO (A) | 115XT HI (A) | FULL (A) | 115XT LO (B) | 115XT HI (B) | FULL (B) |
| 115XT HIQ FILL | 115XT HIQ LO (A) | 115XT HIQ HI (A) | FULL (A) | 115XT HIQ LO (B) | 115XT HIQ HI (B) | FULL (B) |
| 115XT HIQ FRONT | 115XT HIQ LO (A) | 115XT HIQ HI (A) | FULL (A) | 115XT HIQ LO (B) | 115XT HIQ HI (B) | FULL (B) |
| 3-WAY MODULES | | | | | | |
| ARCS 3W SB118 LO | SB118 (A) | ARCS LO (A) | ARCS HI (A) | SB118 (B) | ARCS LO (B) | ARCS HI (B) |
| ARCS 3W SB118 HI | SB118 (A) | ARCS LO (A) | ARCS HI (A) | SB118 (B) | ARCS LO (B) | ARCS HI (B) |
| ARCS 3WX SB118 LO | SB118 (A) | ARCS LO (A) | ARCS HI (A) | SB118 (B) | ARCS LO (B) | ARCS HI (B) |
| ARCS 3WX SB118 HI | SB118 (A) | ARCS LO (A) | ARCS HI (A) | SB118 (B) | ARCS LO (B) | ARCS HI (B) |
| ARCS 3W SB218 LO | SB218 (A) | ARCS LO (A) | ARCS HI (A) | SB218 (B) | ARCS LO (B) | ARCS HI (B) |
| ARCS 3W SB218 HI | SB218 (A) | ARCS LO (A) | ARCS HI (A) | SB218 (B) | ARCS LO (B) | ARCS HI (B) |
| ARCS 3WX SB218 LO | SB218 (A) | ARCS LO (A) | ARCS HI (A) | SB218 (B) | ARCS LO (B) | ARCS HI (B) |
| ARCS 3WX SB218 HI | SB218 (A) | ARCS LO (A) | ARCS HI (A) | SB218 (B) | ARCS LO (B) | ARCS HI (B) |
| ARCS 3W dV-SUB LO | dV-SUB (A) | ARCS LO (A) | ARCS HI (A) | dV-SUB (B) | ARCS LO (B) | ARCS HI (B) |
| ARCS 3W dV-SUB HI | dV-SUB (A) | ARCS LO (A) | ARCS HI (A) | dV-SUB (B) | ARCS LO (B) | ARCS HI (B) |
| ARCS 3WX dV-SUB LO | dV-SUB (A) | ARCS LO (A) | ARCS HI (A) | dV-SUB (B) | ARCS LO (B) | ARCS HI (B) |
| ARCS 3WX dV-SUB HI | dV-SUB (A) | ARCS LO (A) | ARCS HI (A) | dV-SUB (B) | ARCS LO (B) | ARCS HI (B) |
| 112XT 3W SB118 | SB118 (A) | 112XT LO (A) | 112XT HI (A) | SB118 (B) | 112XT LO (B) | 112XT HI (B) |
| 112XT 3WX SB118 | SB118 (A) | 112XT LO (A) | 112XT HI (A) | SB118 (B) | 112XT LO (B) | 112XT HI (B) |
| 112XT 3W SB218 | SB218 (A) | 112XT LO (A) | 112XT HI (A) | SB218 (B) | 112XT LO (B) | 112XT HI (B) |
| 112XT 3WX SB218 | SB218 (A) | 112XT LO (A) | 112XT HI (A) | SB218 (B) | 112XT LO (B) | 112XT HI (B) |
| 112XT 3W dV-SUB | dV-SUB (A) | 112XT LO (A) | 112XT HI (A) | dV-SUB (B) | 112XT LO (B) | 112XT HI (B) |
| 112XT 3WX dV-SUB | dV-SUB (A) | 112XT LO (A) | 112XT HI (A) | dV-SUB (B) | 112XT LO (B) | 112XT HI (B) |
| 115XT 3W SB118 | SB118 (A) | 115XT LO (A) | 115XT HI (A) | SB118 (B) | 115XT LO (B) | 115XT HI (B) |
| 115XT 3WX SB118 | SB118 (A) | 115XT LO (A) | 115XT HI (A) | SB118 (B) | 115XT LO (B) | 115XT HI (B) |
| 115XT 3W SB218 | SB218 (A) | 115XT LO (A) | 115XT HI (A) | SB218 (B) | 115XT LO (B) | 115XT HI (B) |
| 115XT 3WX SB218 | SB218 (A) | 115XT LO (A) | 115XT HI (A) | SB218 (B) | 115XT LO (B) | 115XT HI (B) |
| 115XT 3W dV-SUB | dV-SUB (A) | 115XT LO (A) | 115XT HI (A) | dV-SUB (B) | 115XT LO (B) | 115XT HI (B) |
| 115XT 3WX dV-SUB | dV-SUB (A) | 115XT LO (A) | 115XT HI (A) | dV-SUB (B) | 115XT LO (B) | 115XT HI (B) |
| +2 MODULES (OUTPUTS 5/6) | | | | | | |
| AUX | | | | FULL (B) | FULL (B) | |
| ARCS 2W LO | | | | ARCS LO (B) | ARCS HI (B) | |
| ARCS 2W HI | | | | ARCS LO (B) | ARCS HI (B) | |
| 112XT FILL | | | | 112XT LO (B) | 112XT HI (B) | |
| 112XT FRONT | | | | 112XT LO (B) | 112XT HI (B) | |
| 115XT FILL | | | | 115XT LO (B) | 115XT HI (B) | |
| 115XT FRONT | | | | 115XT LO (B) | 115XT HI (B) | |
| 115XT HIQ FILL | | | | 115XT HIQ LO (B) | 115XT HIQ HI (B) | |
| 115XT HIQ FRONT | | | | 115XT HIQ LO (B) | 115XT HIQ HI (B) | |

Table 9: L-ACOUSTICS modules for Lake Contour



L-ACOUSTICS V7.2 PRESETS for BSS 366 *

| PRESET NAME | PGM TYPE | Mem | OUT 1 (Source) | OUT 2 (Source) | OUT 3 (Source) | OUT 4 (Source) | OUT 5 (Source) | OUT 6 (Source) | |
|--------------------|----------------|-----|--|-------------------|-------------------|------------------|-------------------|------------------|--|
| USER | 3(A)+3(B) | 1 | | | | | | | |
| ARCS 2W LO | 3(A)+3(B) | 2 | FULL (A) | ARCS LOW (A) | ARCS HI (A) | FULL (B) | ARCS LOW (B) | ARCS HI (B) | |
| ARCS 2W HI | 3(A)+3(B) | 3 | FULL (A) | ARCS LOW (A) | ARCS HI (A) | FULL (B) | ARCS LOW (B) | ARCS HI (B) | |
| A 3W 118 LO | 3(A)+3(B) | 4 | SB118 (A) | ARCS LOW (A) | ARCS HI (A) | SB118 (B) | ARCS LOW (B) | ARCS HI (B) | |
| A 3W 118 HI | 3(A)+3(B) | 5 | SB118 (A) | ARCS LOW (A) | ARCS HI (A) | SB118 (B) | ARCS LOW (B) | ARCS HI (B) | |
| A 3WX 118 L | 3(A)+3(B) | 6 | SB118 (A) | ARCS LOW (A) | ARCS HI (A) | SB118 (B) | ARCS LOW (B) | ARCS HI (B) | |
| A 3WX 118 H | 3(A)+3(B) | 7 | SB118 (A) | ARCS LOW (A) | ARCS HI (A) | SB118 (B) | ARCS LOW (B) | ARCS HI (B) | |
| A 3W 218 LO | 3(A)+3(B) | 8 | SB218 (A) | ARCS LOW (A) | ARCS HI (A) | SB218 (B) | ARCS LOW (B) | ARCS HI (B) | |
| A 3W 218 HI | 3(A)+3(B) | 9 | SB218 (A) | ARCS LOW (A) | ARCS HI (A) | SB218 (B) | ARCS LOW (B) | ARCS HI (B) | |
| A 3WX 218 L | 3(A)+3(B) | 10 | SB218 (A) | ARCS LOW (A) | ARCS HI (A) | SB218 (B) | ARCS LOW (B) | ARCS HI (B) | |
| A 3WX 218 H | 3(A)+3(B) | 11 | SB218 (A) | ARCS LOW (A) | ARCS HI (A) | SB218 (B) | ARCS LOW (B) | ARCS HI (B) | |
| A 3W DVS LO | 3(A)+3(B) | 12 | dV-SUB (A) | ARCS LOW (A) | ARCS HI (A) | dV-SUB (B) | ARCS LOW (B) | ARCS HI (B) | |
| A 3W DVS HI | 3(A)+3(B) | 13 | dV-SUB (A) | ARCS LOW (A) | ARCS HI (A) | dV-SUB (B) | ARCS LOW (B) | ARCS HI (B) | |
| A 3WX DVS L | 3(A)+3(B) | 14 | dV-SUB (A) | ARCS LOW (A) | ARCS HI (A) | dV-SUB (B) | ARCS LOW (B) | ARCS HI (B) | |
| A 3WX DVS H | 3(A)+3(B) | 15 | dV-SUB (A) | ARCS LOW (A) | ARCS HI (A) | dV-SUB (B) | ARCS LOW (B) | ARCS HI (B) | |
| I12XT FIL | 3(A)+3(B) | 16 | FULL (A) | I12XT LOW (A) | I12XT HI (A) | FULL (B) | I12XT LOW (B) | I12XT HI (B) | |
| I12XT FOH | 3(A)+3(B) | 17 | FULL (A) | I12XT LOW (A) | I12XT HI (A) | FULL (B) | I12XT LOW (B) | I12XT HI (B) | |
| I12XT MON | 3(A)+3(B) | 18 | FULL (A) | I12XT LOW (A) | I12XT HI (A) | FULL (B) | I12XT LOW (B) | I12XT HI (B) | |
| I12 SB115 | 3(A)+3(B) | 19 | SB115 (A) | I12XT LOW (A) | I12XT HI (A) | SB115 (B) | I12XT LOW (B) | I12XT HI (B) | |
| I12 X 115 | 3(A)+3(B) | 20 | SB115 (A) | I12XT LOW (A) | I12XT HI (A) | SB115 (B) | I12XT LOW (B) | I12XT HI (B) | |
| I12 SB118 | 3(A)+3(B) | 21 | SB118 (A) | I12XT LOW (A) | I12XT HI (A) | SB118 (B) | I12XT LOW (B) | I12XT HI (B) | |
| I12 X 118 | 3(A)+3(B) | 22 | SB118 (A) | I12XT LOW (A) | I12XT HI (A) | SB118 (B) | I12XT LOW (B) | I12XT HI (B) | |
| I12 SB218 | 3(A)+3(B) | 23 | SB218 (A) | I12XT LOW (A) | I12XT HI (A) | SB218 (B) | I12XT LOW (B) | I12XT HI (B) | |
| I12 X 218 | 3(A)+3(B) | 24 | SB218 (A) | I12XT LOW (A) | I12XT HI (A) | SB218 (B) | I12XT LOW (B) | I12XT HI (B) | |
| I12 dVS | 3(A)+3(B) | 25 | dV-SUB (A) | I12XT LOW (A) | I12XT HI (A) | dV-SUB (B) | I12XT LOW (B) | I12XT HI (B) | |
| I12 X dVS | 3(A)+3(B) | 26 | dV-SUB (A) | I12XT LOW (A) | I12XT HI (A) | dV-SUB (B) | I12XT LOW (B) | I12XT HI (B) | |
| I15XT FIL | 3(A)+3(B) | 27 | FULL (A) | I15XT LOW (A) | I15XT HI (A) | FULL (B) | I15XT LOW (B) | I15XT HI (B) | |
| I15XT FOH | 3(A)+3(B) | 28 | FULL (A) | I15XT LOW (A) | I15XT HI (A) | FULL (B) | I15XT LOW (B) | I15XT HI (B) | |
| I15XT MON | 3(A)+3(B) | 29 | FULL (A) | I15XT LOW (A) | I15XT HI (A) | FULL (B) | I15XT LOW (B) | I15XT HI (B) | |
| I15 SB115 | 3(A)+3(B) | 30 | SB115 (A) | I15XT LOW (A) | I15XT HI (A) | SB115 (B) | I15XT LOW (B) | I15XT HI (B) | |
| I15 X 115 | 3(A)+3(B) | 31 | SB115 (A) | I15XT LOW (A) | I15XT HI (A) | SB115 (B) | I15XT LOW (B) | I15XT HI (B) | |
| I15 SB118 | 3(A)+3(B) | 32 | SB118 (A) | I15XT LOW (A) | I15XT HI (A) | SB118 (B) | I15XT LOW (B) | I15XT HI (B) | |
| I15 X 118 | 3(A)+3(B) | 33 | SB118 (A) | I15XT LOW (A) | I15XT HI (A) | SB118 (B) | I15XT LOW (B) | I15XT HI (B) | |
| I15 SB218 | 3(A)+3(B) | 34 | SB218 (A) | I15XT LOW (A) | I15XT HI (A) | SB218 (B) | I15XT LOW (B) | I15XT HI (B) | |
| I15 X 218 | 3(A)+3(B) | 35 | SB218 (A) | I15XT LOW (A) | I15XT HI (A) | SB218 (B) | I15XT LOW (B) | I15XT HI (B) | |
| I15 dVS | 3(A)+3(B) | 36 | dV-SUB (A) | I15XT LOW (A) | I15XT HI (A) | dV-SUB (B) | I15XT LOW (B) | I15XT HI (B) | |
| I15 X dVS | 3(A)+3(B) | 37 | dV-SUB (A) | I15XT LOW (A) | I15XT HI (A) | dV-SUB (B) | I15XT LOW (B) | I15XT HI (B) | |
| HIQ FILL | 3(A)+3(B) | 38 | FULL (A) | I15XT HIQ LOW (A) | I15XT HIQ HI (A) | FULL (B) | I15XT HIQ LOW (B) | I15XT HIQ HI (B) | |
| HIQ FOH | 3(A)+3(B) | 39 | FULL (A) | I15XT HIQ LOW (A) | I15XT HIQ HI (A) | FULL (B) | I15XT HIQ LOW (B) | I15XT HIQ HI (B) | |
| HIQ MON | 3(A)+3(B) | 40 | FULL (A) | I15XT HIQ LOW (A) | I15XT HIQ HI (A) | FULL (B) | I15XT HIQ LOW (B) | I15XT HIQ HI (B) | |
| I15FM 2W | 3(A)+3(B) | 41 | FULL (A) | I15FM LOW (A) | I15FM HI (A) | FULL (B) | I15FM LO (B) | I15FM HI (B) | |
| I15FM 2WX | 3(A)+3(B) | 42 | FULL (A) | I15FM LOW (A) | I15FM HI (A) | FULL (B) | I15FM LO (B) | I15FM HI (B) | |
| FM SB115 | 3(A)+3(B) | 43 | SB115 (A) | I15FM LOW (A) | I15FM HI (A) | SB115 (B) | I15FM LOW (B) | I15FM HI (B) | |
| FM SB118 | 3(A)+3(B) | 44 | SB118 (A) | I15FM LOW (A) | I15FM HI (A) | SB118 (B) | I15FM LOW (B) | I15FM HI (B) | |
| FM SB218 | 3(A)+3(B) | 45 | SB218 (A) | I15FM LOW (A) | I15FM HI (A) | SB218 (B) | I15FM LOW (B) | I15FM HI (B) | |
| FM dVSUB | 3(A)+3(B) | 46 | dV-SUB (A) | I15FM LOW (A) | I15FM HI (A) | dV-SUB (B) | I15FM LOW (B) | I15FM HI (B) | |
| | | 47 | INTENTIONALLY BLANK (3 x 2-way presets follow) | | | | | | |
| ARCS 2W LO | 2(A)+2(B)+2(C) | 48 | ARCS LOW (A) | ARCS HI (A) | ARCS LOW (B) | ARCS HI (B) | ARCS LOW (C) | ARCS HI (C) | |
| ARCS 2W HI | 2(A)+2(B)+2(C) | 49 | ARCS LOW (A) | ARCS HI (A) | ARCS LOW (B) | ARCS HI (B) | ARCS LOW (C) | ARCS HI (C) | |
| HIQ FILL | 2(A)+2(B)+2(C) | 50 | I15XT HIQ LOW (A) | I15XT HIQ HI (A) | I15XT HIQ LOW (B) | I15XT HIQ HI (B) | I15XT HIQ LOW (C) | I15XT HIQ HI (C) | |
| HIQ FOH | 2(A)+2(B)+2(C) | 51 | I15XT HIQ LOW (A) | I15XT HIQ HI (A) | I15XT HIQ LOW (B) | I15XT HIQ HI (B) | I15XT HIQ LOW (C) | I15XT HIQ HI (C) | |
| HIQ MON | 2(A)+2(B)+2(C) | 52 | I15XT HIQ LOW (A) | I15XT HIQ HI (A) | I15XT HIQ LOW (B) | I15XT HIQ HI (B) | I15XT HIQ LOW (C) | I15XT HIQ HI (C) | |
| I15FM 2W | 2(A)+2(B)+2(C) | 53 | I15FM LOW (A) | I15FM HI (A) | I15FM LOW (B) | I15FM HI (B) | I15FM LOW (C) | I15FM HI (C) | |
| I15FM 2WX | 2(A)+2(B)+2(C) | 54 | I15FM LOW (A) | I15FM HI (A) | I15FM LOW (B) | I15FM HI (B) | I15FM LOW (C) | I15FM HI (C) | |
| I12XT FIL | 2(A)+2(B)+2(C) | 55 | I12XT LOW (A) | I12XT HI (A) | I12XT LOW (B) | I12XT HI (B) | I12XT LOW (C) | I12XT HI (C) | |
| I12XT FOH | 2(A)+2(B)+2(C) | 56 | I12XT LOW (A) | I12XT HI (A) | I12XT LOW (B) | I12XT HI (B) | I12XT LOW (C) | I12XT HI (C) | |
| I12XT MON | 2(A)+2(B)+2(C) | 57 | I12XT LOW (A) | I12XT HI (A) | I12XT LOW (B) | I12XT HI (B) | I12XT LOW (C) | I12XT HI (C) | |
| I15XT FIL | 2(A)+2(B)+2(C) | 58 | I15XT LOW (A) | I15XT HI (A) | I15XT LOW (B) | I15XT HI (B) | I15XT LOW (C) | I15XT HI (C) | |
| I15XT FOH | 2(A)+2(B)+2(C) | 59 | I15XT LOW (A) | I15XT HI (A) | I15XT LOW (B) | I15XT HI (B) | I15XT LOW (C) | I15XT HI (C) | |
| I15XT MON | 2(A)+2(B)+2(C) | 60 | I15XT LOW (A) | I15XT HI (A) | I15XT LOW (B) | I15XT HI (B) | I15XT LOW (C) | I15XT HI (C) | |

*L-ACOUSTICS V7.2 PRESETS MUST BE USED WITH BSS 366 VERSION 1.10 FIRMWARE (OR HIGHER)

Table 10: BSS 366 Omnidrive Compact Plus Presets

4. SOUND DESIGN

4.1 APPLICATIONS

The art of designing a sound system is a profession in itself and a complete description of all sound system design aspects is beyond the scope of this manual. If necessary, we recommend the use of a specialized sound engineer or consultant since *the best products can produce the worst results if improperly set-up*. In order to get the best results, it is important to follow correct sound design principles, properly integrate ARCS with subwoofers, use the correct power amplification and use the correct OEM digital signal processor preset.

In general terms, ARCS is primarily intended for medium-scale Front-Of-House (FOH) sound reinforcement. ARCS is a high-Q design, capable of producing very high SPL output despite its compact size. When arrayed, coupling occurs at low and mid frequencies until the frequency is high enough to enter the "individual" mode where individual waveguides of each enclosure control the directivity of the emitted wavefront at 22.5° horizontal. At frequencies higher than this limit (approximately 2 kHz), the SPL output of the array is limited to that of a single enclosure and the SPL is directly determined by the Q factor of the HF waveguide. For this reason, the throw of an ARCS array can be considered to be independent of the number of enclosures.

Since an ARCS array has constant directivity behavior it is important not to have the very first part of the audience too close to the system (i.e., in order not to produce excessive SPLs up close). Ideally, the ratio between the shortest and furthest distance covered should not exceed 1:4 and for this reason it is often desirable to fly the system. However, when ARCS is flown and the audience seating area begins very close to the stage, it is sometimes necessary to use distributed front-fill speakers (for example, L-ACOUSTICS MTD108a) or a ground stacked left/right ARCS stereo infill system in order to improve coverage and image localization for the first rows of the audience.

ARCS is typically arrayed in a number and configuration based on the geometry of the audience to be covered. In the normal (vertical orientation) the horizontal coverage of each enclosure is 22.5° and the total horizontal coverage of the array is a multiple of 22.5°. For a single row ARCS array, the vertical coverage is asymmetrical, providing +40 degrees by -20 degrees and cabinets can either be flown in the normal orientation (for up-fill) or inverted (for down-fill).

When ARCS is used in a double row configuration, the top row cabinets are oriented in the normal position for up-fill (+40 degrees) and the bottom row cabinets inverted for down-fill (-40 degrees). Double row configurations are typically used to improve low frequency impact due to the enhanced low frequency coupling obtained since all 15" loudspeakers satisfy WST Condition #2 (acoustic center separation is less than half wavelength over the entire operating bandwidth).

With the use of ARCBUMP, 1- 4 ARCS can be flown horizontally. In this orientation, horizontal coverage is 60° (asymmetrical) and for L/R FOH applications, ARCS is normally oriented with the 40° angle directed onstage (i.e., L-ACOUSTICS logos of the left and right enclosures oriented in the offstage direction). Vertical coverage angles are : 22.5, 45, 67.5 and 90 degrees for 1, 2, 3, 4 ARCS respectively.

The choice of whether to fly ARCS vertically (waveguides oriented horizontally) or horizontally (waveguides oriented vertically) will depend on the geometry of the room – ensuring adequate audience coverage is of course a major consideration and another important issue concerns whether it is more desirable to avoid wall or ceiling reflections. For the first case, it is best to use ARCS vertically and align the outside edge of the offstage enclosure parallel to the wall surface. For the second case, it is best to rig ARCS horizontally in order to reduce ceiling reflections.

Note: Please refer to the ARCS Rigging Reference Charts in Section 5 for a summary of array tilt angles versus BUMP3, LIFTBAR and ARCBUMP pick points for different array configurations.

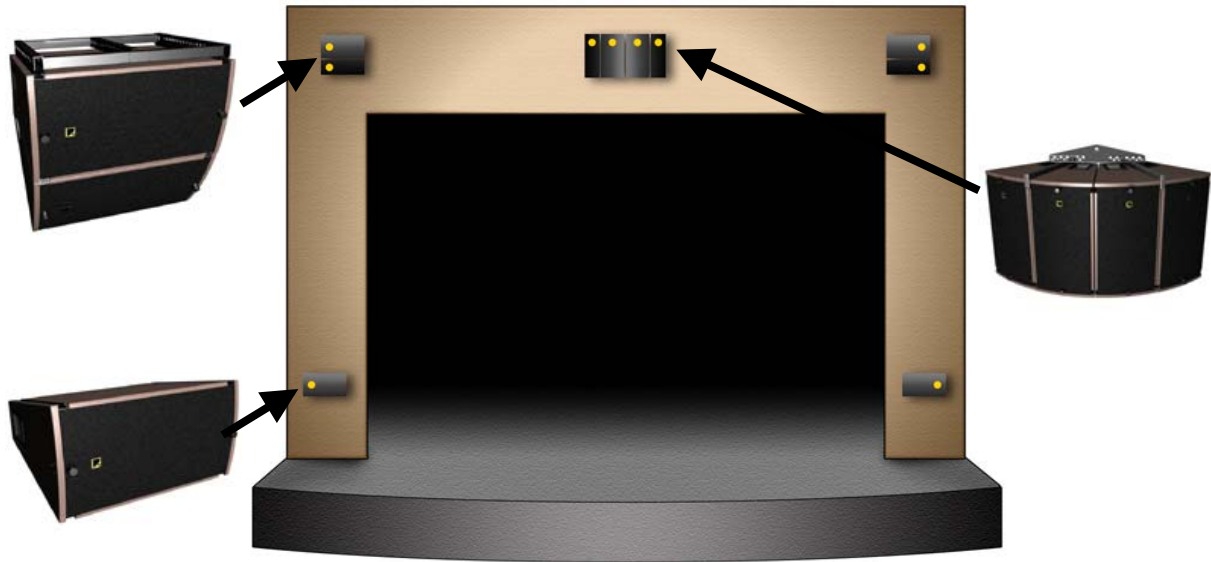

Figure 19: Theatrical Sound Design Example (proscenium-mounted LCR array with stereo infill loudspeakers, optional distributed front fill system not shown)

4.2 ARRAY AIMING

In general, an ARCS array should be aimed so as to geometrically cover the desired audience area with the main zero degree axis oriented towards the middle of this area. This is unlike conventional speaker systems which are typically aimed at the rearmost part of the audience.

The first task is to map the coverage of an ARCS array in the vertical plane (i.e., section cutview) in order to see how it matches the audience area to be covered and L-ACOUSTICS' proprietary ARRAY or SOUNDVISION (see Section 4.3) software is useful for this purpose. Although specific ARCS modeling is not included in ARRAY, the following procedure will give an estimate as to the vertical coverage:

Enter: X1, Z1, X2, Z2 in the Cutview 1 cells (X = range, Z = elevation) to define to a section profile of the given audience geometry (see V-DOSC or dV-DOSC manuals for further details)

Enter: 3 for “# of Elements”

Enter: 40 for “#1 to next” for the normal orientation (or 20 for “#1 to next” for inverted)

Enter: 20 for “#2 to next” for the normal orientation (or 40 for “#2 to next” for inverted)

Adjust: “Bumper Elevation”, “Autofocus Adjust” parameters until audience coverage is satisfactory

Refer to: “Site” for “#2 to next” and the ARCS Rigging Reference Chart in Section 5 to determine the appropriate BUMP3 / LIFTBAR pick point.

Refer to: “Bumper Elevation” to determine the system trim height.

When ARCS is used in the vertical orientation, it is easy to visually check the horizontal coverage of an ARCS array since the coverage area is effectively defined by the outer walls of the outer cabinets of the array. Basically, if you can see the outside cabinet wall (onstage or offstage), you are outside of the coverage pattern.

Note: A useful technique in theatres or conference rooms is to align the outside wall of the offstage ARCS enclosure parallel to the wall surface in order to avoid wall reflections.

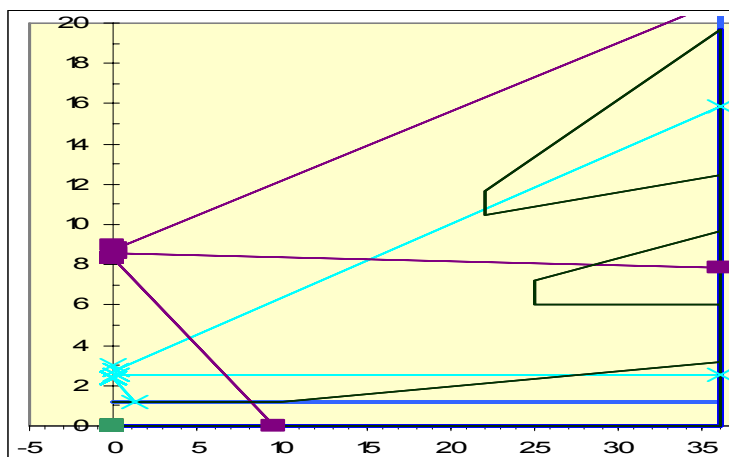

Figure 20: ARRAY Cutview simulation of an ARCS installation for theatrical sound reinforcement. The flown and ground stacked ARCS arrays are both inverted to provide +20/-40 degree coverage.

CAD tools for AUTOCAD are also available for representing ARCS horizontal and vertical coverage (see www.l-acoustics.com or the L-ACOUSTICS Technical Resources CDROM):

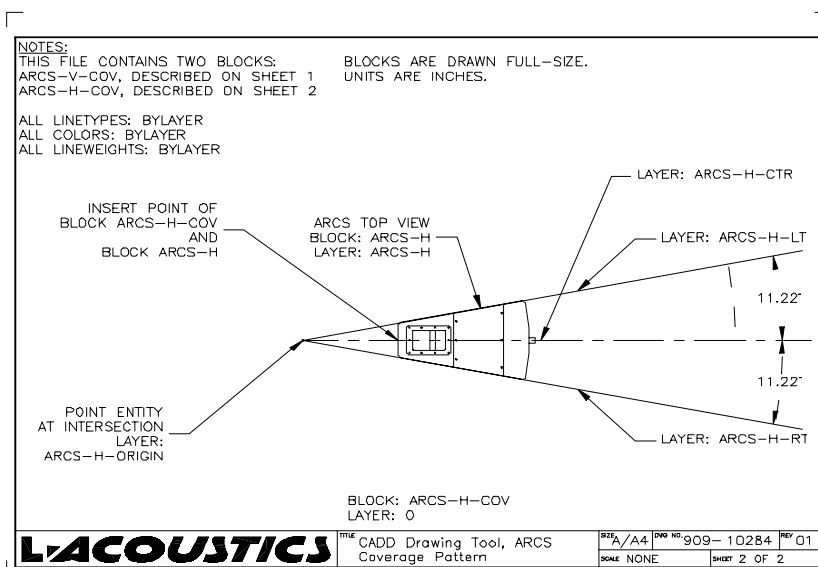
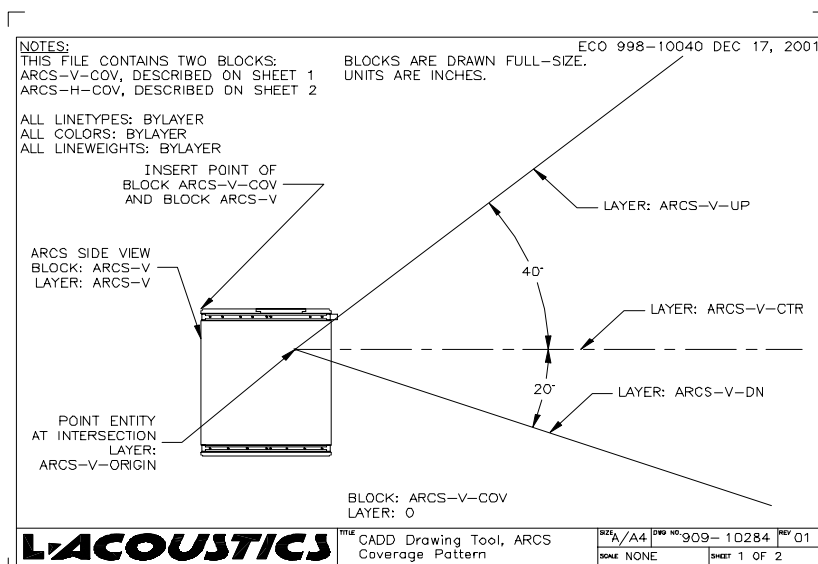

Figure 21: AUTOCAD utilities for representing ARCS horizontal and vertical coverage.

4.3 ARCS COVERAGE MODELING USING SOUNDVISION

L-ACOUSTICS SOUNDVISION is a proprietary 3D software program dedicated to the modeling of the entire L-ACOUSTICS product line - including ARCS. Designed with a convenient, intuitive graphical user interface, SOUNDVISION allows for the calculation of sound pressure level (SPL) and coverage mapping for complex sound system or venue configurations.

Room geometry and loudspeaker locations are defined in 3D and simplified operating modes allow the user to work in 2D to rapidly enter data. According to user preference, either horizontal (plan) or vertical (cut) views can be selected to enter room coordinates or to define loudspeaker placement/aiming. SPL plus coverage mapping are then based on direct sound calculations over the defined audience geometry.

SOUNDVISION features a user-friendly interface with multiple toolboxes that allow for convenient entry of room and loudspeaker data while at the same time displaying coverage or mapping results along with 2D Cutview, Target and Source Cutview information. All toolboxes can be displayed simultaneously, providing the user with a complete control interface that allows for rapid system optimization.

Using sophisticated modeling algorithms, SOUNDVISION offers several levels of support for users of L-ACOUSTICS products. Due to its speed and ease-of-use, "Impact" mode is well-suited to the needs of touring sound engineers and touring sound companies. More detailed information is available in "SPL Mapping" mode, providing an invaluable tool for the audio consultant or sound designer. For the installer, the physical properties provided in "Mechanical Data" mode provide useful practical information for fixed installation applications.

Impact mode coverage is based on the -6 dB directivity over a 1-10 kHz operating bandwidth (at 5 degree angular resolution) and allows for immediate visualization of system coverage and SPL distribution. Optimum SPL contours are highlighted within the displayed -6 dB coverage pattern (filled circles corresponding to the -3 dB coverage pattern) in order to facilitate the implementation of multiple source installations. For distributed sound reinforcement design using coaxial loudspeakers or multiple ARCS arrays, the goal is to align the filled circles in order to have even coverage.

Mapping mode provides a color-coded representation of the SPL distribution over the defined room geometry and allows for visualization of the coverage of individual loudspeakers as well as the interference between multiple loudspeakers. In mapping mode, the user can select individual one third octave bandwidths (as shown in Fig 22), unweighted or A-weighted SPL, or any frequency range between 100 – 10k Hz (as shown in Fig 23). Typically a 1-10 kHz bandwidth SPL mapping is considered to provide a good representation of system performance since this frequency bandwidth is primarily responsible for the perceived system intelligibility and clarity.

Figure 22 shows plan view SPL mappings at octave band frequencies for an array of 4 ARCS enclosures in the vertical orientation (i.e., waveguides are horizontal). For this example, the ARCS array is perpendicular with a 20 metre throw distance to a target plane having dimensions of 40 x 40 metres (imagine the ARCS array flown above the target plane firing straight down). In this plan view representation, the 40 degree coverage for the array is seen to be oriented upwards and the 20 degree coverage downwards. Horizontally, the array provides 90 degree coverage (approximately 24 metres wide as seen in the plan view projection for this example) and coverage is stable and well-defined above 2 kHz while becoming progressively more omnidirectional at lower frequencies.

Note: For color versions of Figures 22, 23 and 24 see the ARCS manual PDF file available for download on www.l-acoustics.com

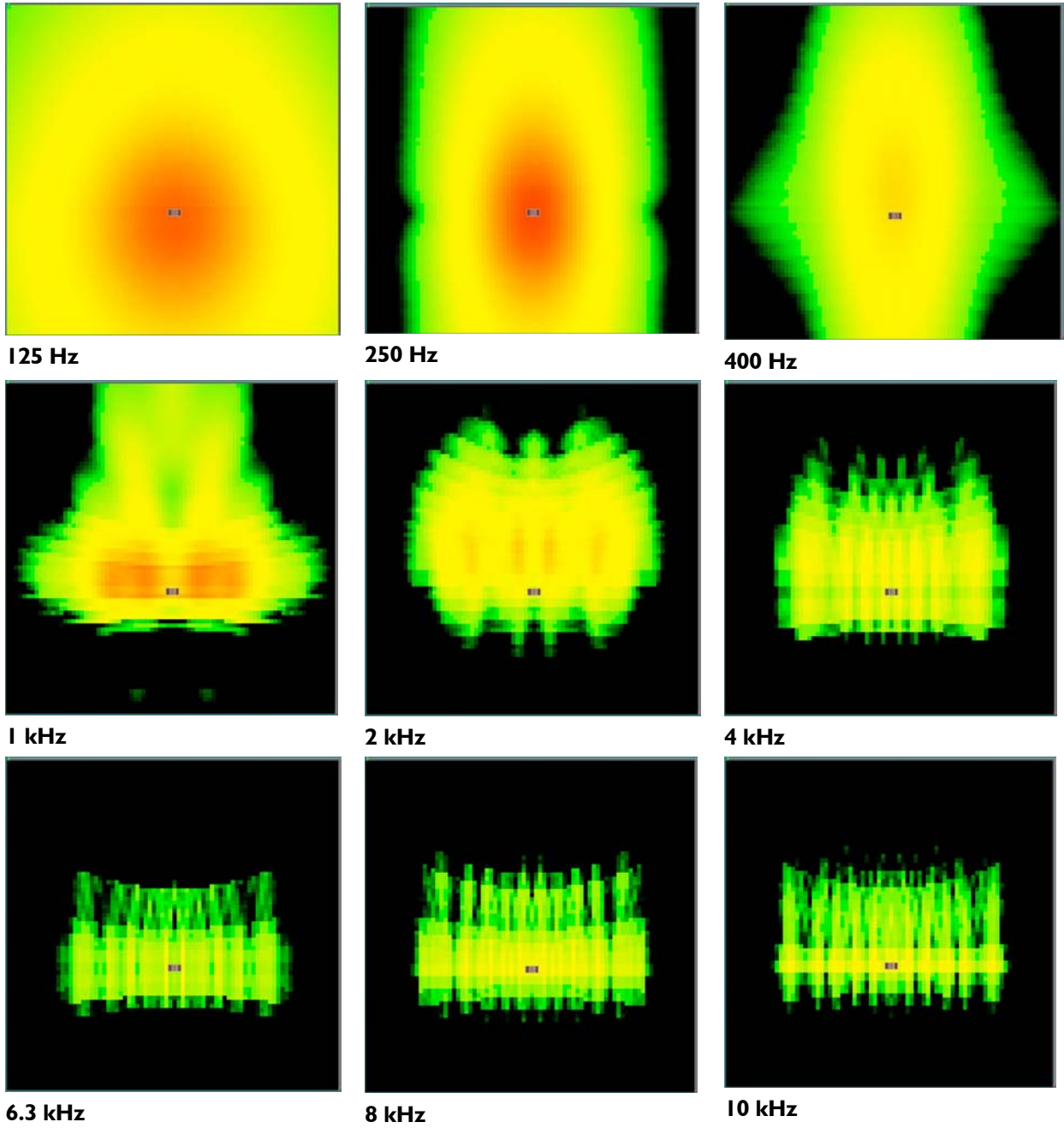
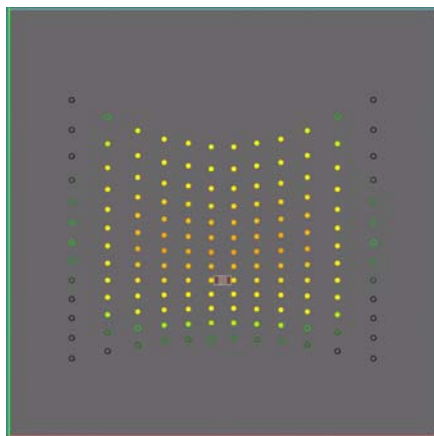

Figure 22: Plan view SPL mappings at octave band frequencies for 4 ARCS arrayed vertically (20 metre throw distance, enclosures are perpendicular to target plane with 40 degree coverage oriented upwards)

Figure 23 shows impact mode coverage and band-averaged SPL mappings for the array of 4 ARCS enclosures pictured in Figure 22. Impact coverage provides a good representation of the octave band mappings seen in Fig. 22 for frequencies higher than 2 kHz. For this reason, impact mode is considered to provide a good indication as to the overall coverage of the array in terms of clarity and intelligibility.

It is also interesting to compare the A-weighted, unweighted and 1-10 kHz SPL mappings of Figure 23 with the individual octave band mappings of Figure 22. The 1-10 kHz SPL mapping is seen to provide a good representation of the overall coverage of the array and also corresponds well with the coverage predicted in impact mode. The A-weighted SPL average provides a more strict representation of system coverage since there is more emphasis on higher frequencies while the unweighted mapping is more omnidirectional due to the inclusion of lower frequency information in the average.



Impact Coverage

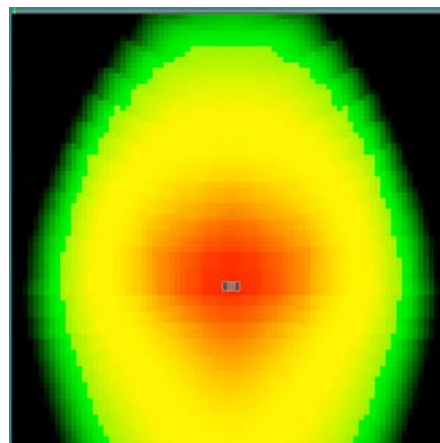

Unweighted SPL Map

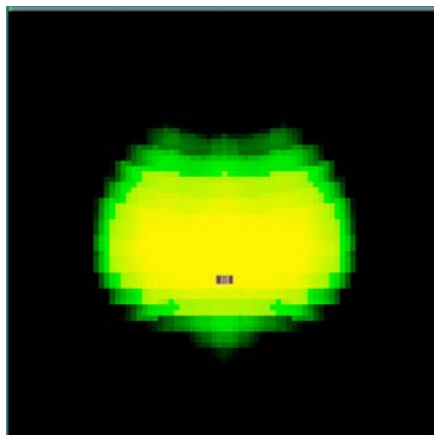

A Weighted SPL Map

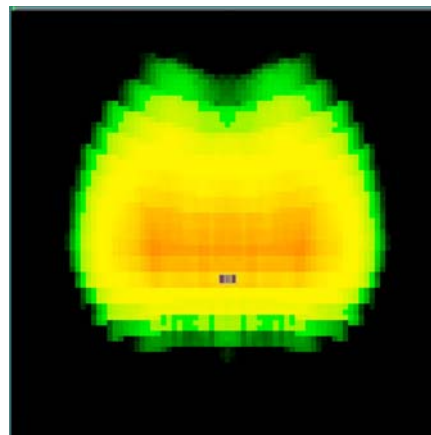

1-10 kHz SPL Map

Figure 23: Impact coverage and SPL mappings (unweighted, A-weighted, 1-10 kHz bandwidth) for 4 ARCS (20 metre throw distance, enclosures perpendicular to target plane with 40 deg coverage oriented upwards)

A full description of SOUNDVISION is beyond the scope of this manual, however a brief example is presented in the following before turning to a more general description of ARCS applications. For any of these applications, SOUNDVISION or ARRAY can be used to predict system coverage and to determine all installation parameters.

Figure 24 shows impact mode and A-weighted SPL mappings for the theatrical sound design configuration depicted in Fig. 19. For this example, the system consists of a proscenium-mounted LCR configuration with two stereo infill ARCS enclosures flown horizontally. The FOH L and R arrays consist of 3 ARCS flown horizontally in a mirror image configuration (40 degree coverage oriented onstage) and a centre cluster of 4 ARCS is flown vertically (inverted orientation).

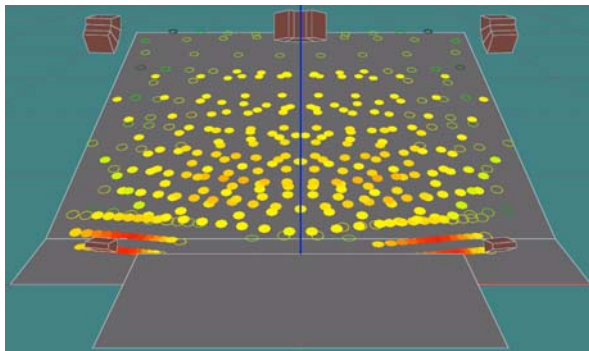

Full System Impact Coverage

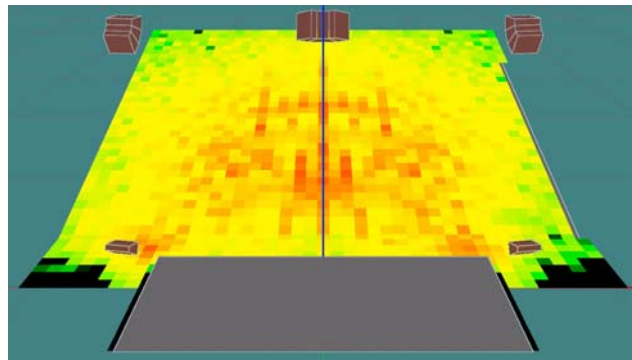

Full System A-Weighted SPL Map

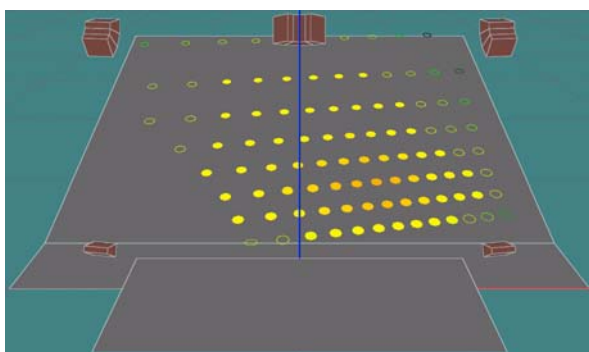

FOH L Impact Coverage

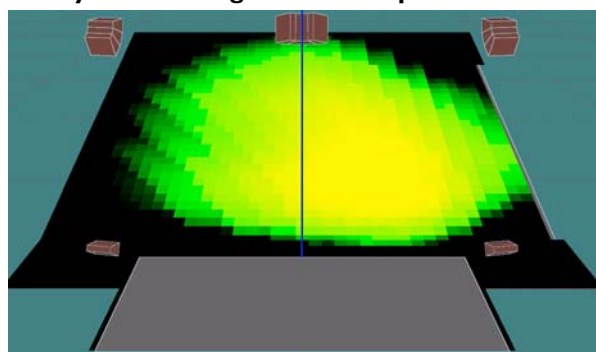

FOH L A-Weighted SPL Map

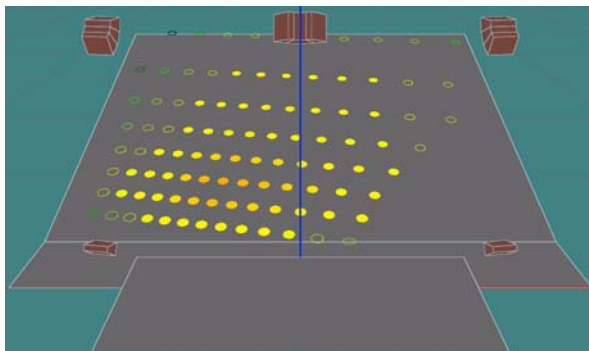

FOH R Impact Coverage

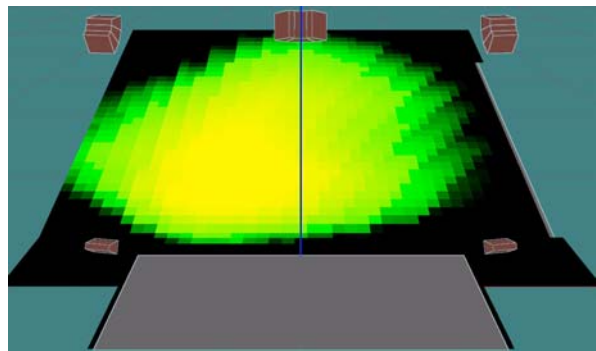

FOH R A-Weighted SPL Map

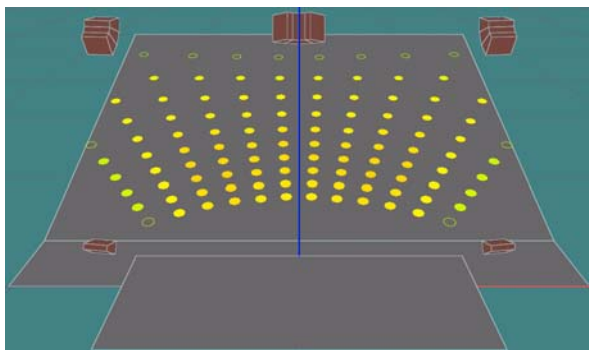

Centre Cluster Impact Coverage

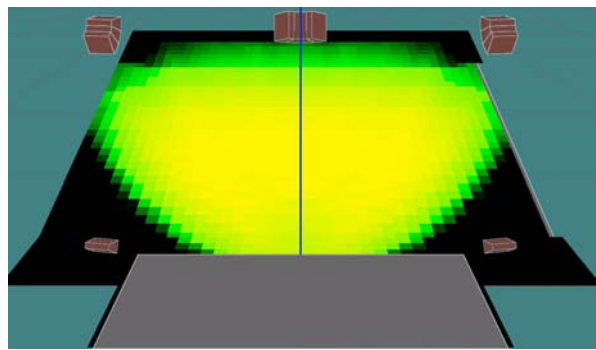

Centre Cluster A-Weighted SPL Map

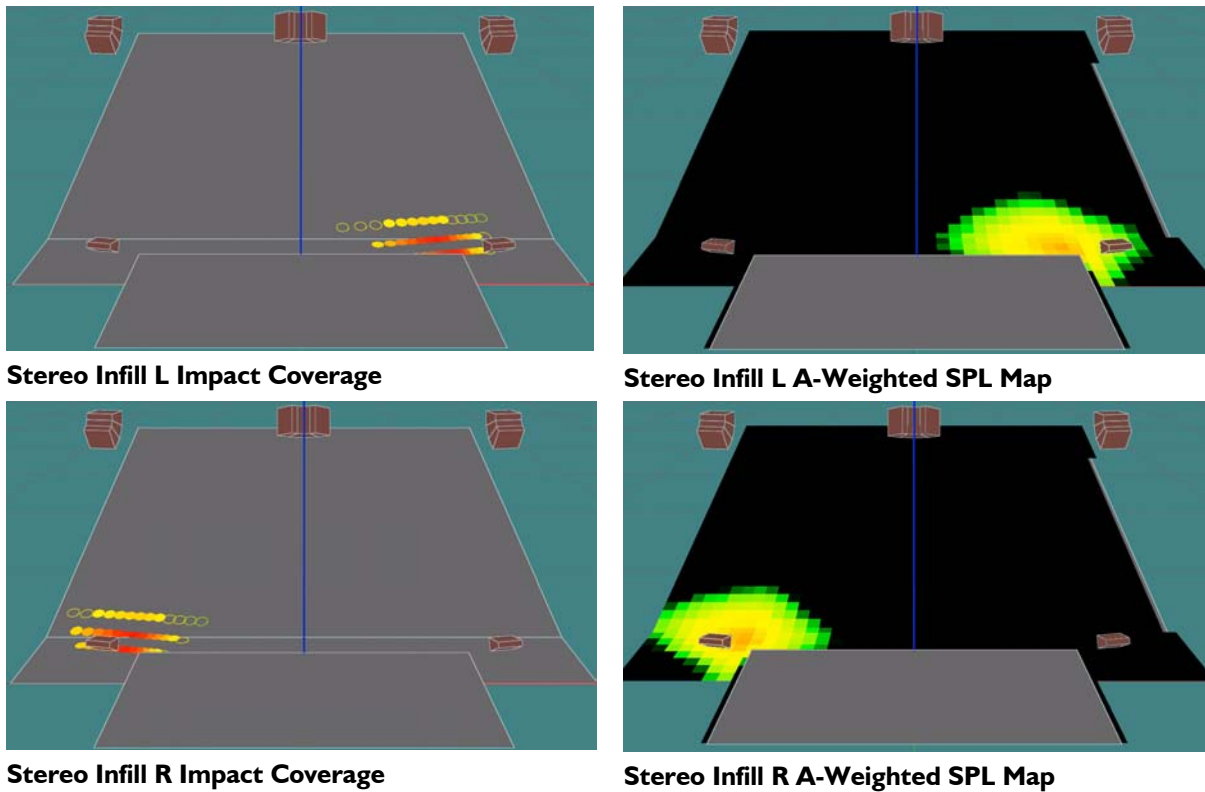

Figure 24: Impact coverage and A-weighted SPL mappings for the theatrical sound design example of Figure 19

4.4 FRONT OF HOUSE APPLICATIONS

Given its' compact size, modular design and flexibility in terms of subwoofer combinations, ARCS is ideal for medium-scale FOH use in theatres, clubs or similar-sized venues. Typically, ARCS is recommended for up to 30 metre throw distances although in double row configurations, ARCS has been used for larger scale arena touring with the addition of rear delays.

Different FOH options will be discussed in this section including: single row arrays, double row arrays, 360 degree coverage and use of ARCS in either vertical or horizontal orientations.



Figure 25: Stacked ARCS FOH system (including dV-SUB and dV-DOSC centre cluster)

4.4.1 SINGLE ROW VERTICAL ARRAYS

An ARCS array behaves as a constant directivity single source with an apparent acoustic center located at 1.15 m behind the array due to the modular curvature of the radiated wavefront. At lower frequencies, directivity control occurs at a frequency that varies according to the number of enclosures. The larger the array, the lower the frequency where directivity control is obtained.

The horizontal coverage is $N \times 22.5^\circ$ (where N is the number of ARCS) and the vertical coverage of a single row array is the same as for a single enclosure regardless of the number of ARCS in the array (i.e., 60° total : 40° up, 20° down when the main axis is at 0° and the cabinets are in the normal orientation). The orientation of the ARCS enclosures (normal or inverted) will depend on the trim height of the flown or stacked array and the audience geometry. In most cases, there is no need to tilt a flown array - if tilt is required, it is typically by a much smaller angle than is required for symmetrically radiating systems (see also 4.2 ARRAY AIMING and 4.3 COVERAGE MODELING USING SOUNDVISION).

As stated in Section 4.2, when ARCS is used in the vertical orientation, it is easy to visually check the horizontal coverage of the array since the coverage area is effectively defined by the outer walls of the outer cabinets of the array. Basically, if you can see the outside cabinet wall (onstage or offstage), you are outside of the coverage pattern.

Note: A useful technique in theatres or conference rooms is to align the outside wall of the offstage ARCS enclosure parallel to the wall surface in order to avoid wall reflections.

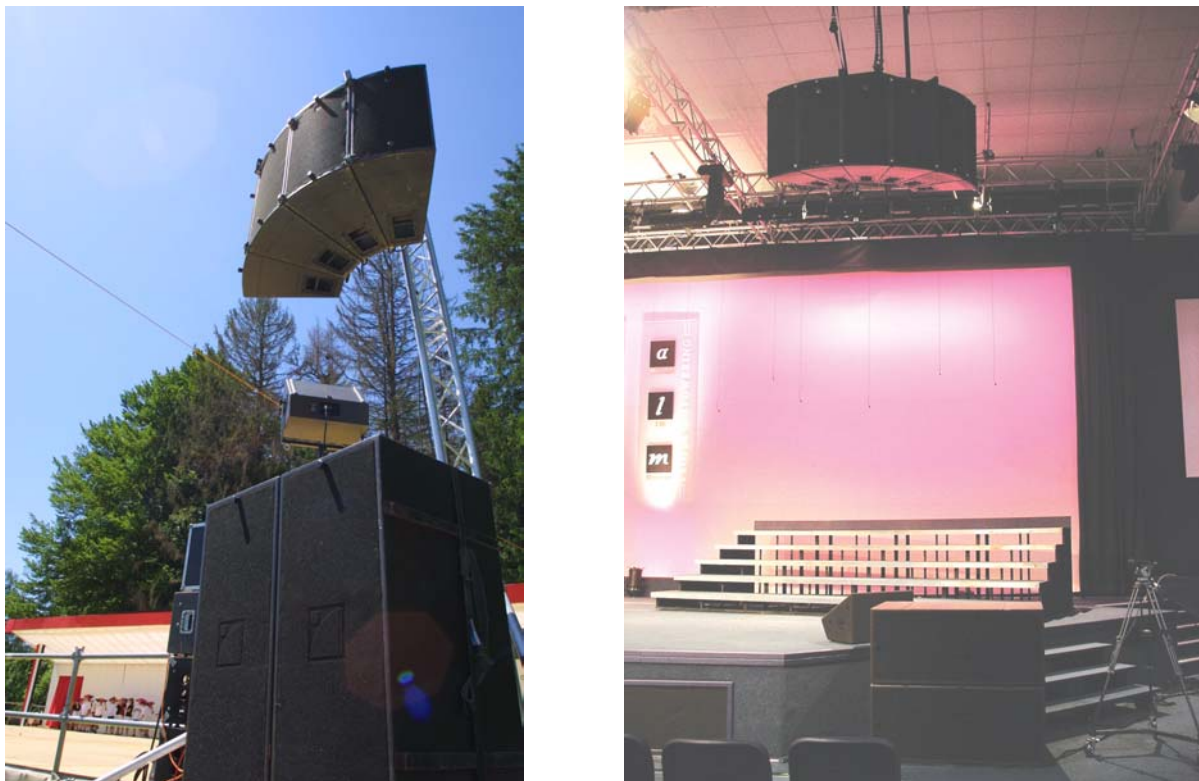

Figure 26: Single Row ARCS Array Examples

4.4.2 SINGLE ROW 360 DEGREE

As seen in Figure 27, a single row of 16 ARCS enclosures provides complete 360 degree horizontal coverage. The only limitation of this configuration is the potential for low frequency buildup directly underneath the array. Depending on the application, high pass filtering can help improve feedback resistance (applied to microphones used for speech reinforcement, for example) and, in some circumstances, the polarity of half the system can be inverted in order to improve low frequency rejection. The latter option can be used provided that the transition region between the positive and negative polarity halves of the array can be focused in an area where there is no audience present.

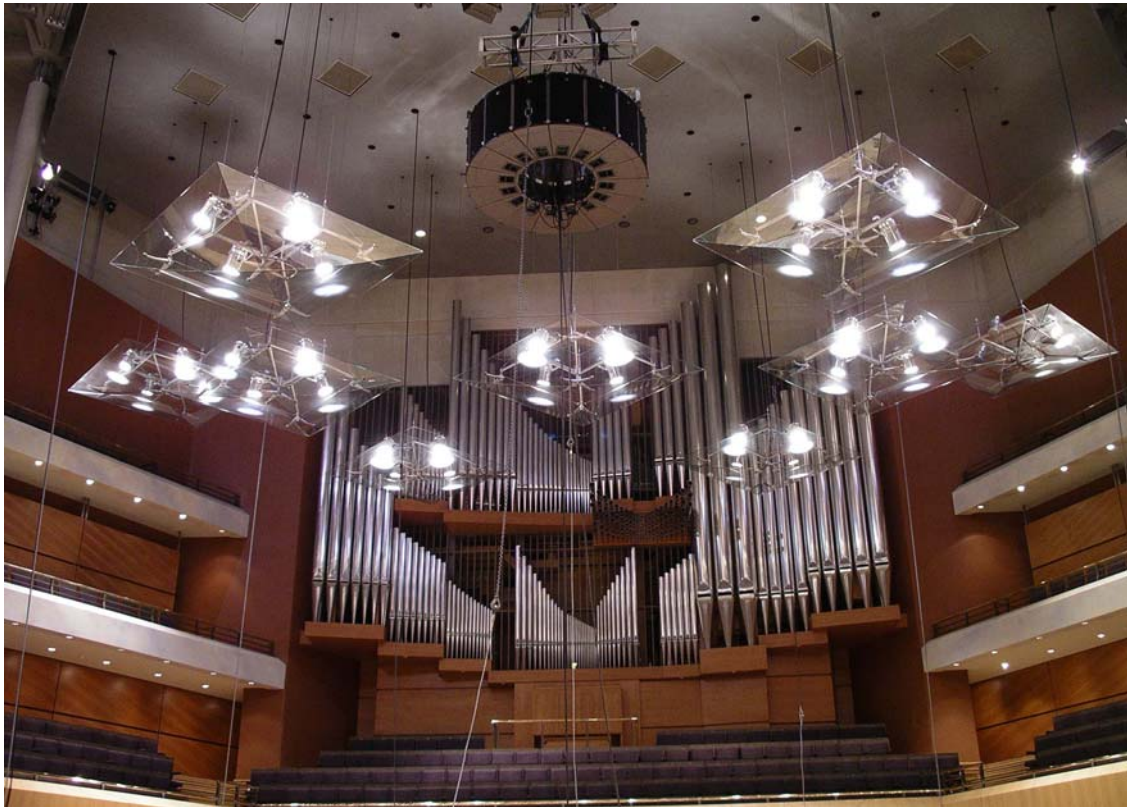

Figure 27: Single Row 360 Degree Coverage ARCS Array

4.4.3 DOUBLE ROW ARRAYS

For larger scale applications with expanded vertical coverage or longer throw requirements, ARCS can be used in a double row configuration with top row cabinets oriented in the normal position for up-fill and the bottom row cabinets inverted for down-fill. When arrayed in this manner (logos together as a quick visual reference), all 15" loudspeakers satisfy Wavefront Sculpture Technology Criteria and couple over their entire operating bandwidth, thus providing maximum low frequency impact and throw due to enhanced directivity control at lower frequencies.

The HF sections are oriented with +40/-20 degrees coverage for the top row and +20/-40 degrees for the bottom row providing an overall vertical coverage angle of 80 degrees total. Given the physical separation of the HF sections, the 20 degree coverage angles of the top and bottom sections do not start to interact until a distance of 10 meters and interference effects at greater distances tend to be masked by room reverberation and the psychoacoustics of tightly spaced comb filtering at higher frequencies which is difficult for the ear to resolve. However, to help minimize this interaction it can be useful to apply a separate time delay to the bottom row of ARCS enclosures so that the bottom row is time aligned with respect to the top row at the FOH mix position (or approximately 30 metres from the system as a reference point).

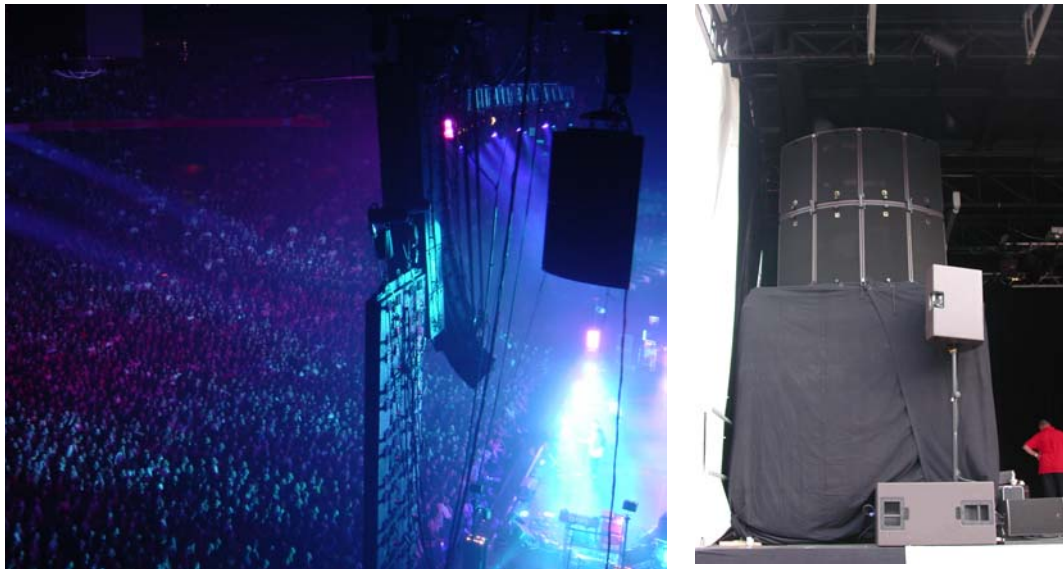

Figure 28: Double Row ARCS Array (offstage fill example, stacked FOH example)

4.4.4 HORIZONTALLY-FLOWN ARRAYS

As stated in Section 4.1, the choice of whether to fly ARCS vertically (waveguides oriented horizontally) or horizontally (waveguides oriented vertically) will depend on the audience geometry and whether it is more desirable to avoid wall or ceiling reflections. Typically, it is best to rig ARCS horizontally in order to avoid ceiling reflections and the left/right FOH arrays are flown mirror-imaged so that the 40 degree coverage for both sides is oriented in the onstage direction.

For horizontally-flown ARCS arrays, it is easy to visually check the vertical coverage of the array since the coverage area is effectively defined by the outer walls of the top and bottom cabinets of the array. Basically, if you can see the bottom wall of the bottom ARCS enclosure, you are outside of the coverage pattern. For the top ARCS enclosure, similar techniques as are used for installing V-DOSC or dV-DOSC can be used for adjusting the overall tilt angle of the flown system, i.e., a laser can be installed on the top ARCS enclosure to serve as a site angle reference to check the focus of the system at the rear part of the audience.



Figure 29: Horizontally Flown ARCS Array

4.5 MONITOR APPLICATIONS

4.5.1 MONITOR SIDE-FILL

Due to its tight directivity pattern and compact size, ARCS is an excellent solution for flown or stacked side-fill applications. The modular 22.5 degree horizontal coverage of ARCS is very practical in determining the extension of the sound field onstage and, in most cases, the outside wall of the ARCS enclosure that is furthest downstage is aligned parallel to the edge of the stage lip in order to prevent spill from the side-fill system into the audience area. Due to this precise coverage and its excellent feedback resistance, ARCS is one of the highest performance side-fill systems available.

Single or two enclosure ARCS arrays are the most common set-up for side-fill applications and ARCS can be used with or without subwoofers depending on the amount of LF extension expected by the monitor engineer or performing artist. For a low profile sidefill solution, ARCS can even be laid on the stage on their sides – given the typical throw distances involved, the 22.5 degree vertical directivity provides good coverage at the centre stage location.

When stacked on top of one or two horizontally-oriented SB218 subwoofers, up to 4 ARCS can be used depending on horizontal coverage requirements. In the horizontal orientation, 2 SB218s provide a good footprint for stacking up to 4 ARCS. The vertical orientation for ARCS is in the normal position, with the 40° radiation pattern directed upwards (i.e., logo at the bottom). SB218 subwoofers can also be used vertically (i.e., standing on their sides) in order to have ARCS sidefill enclosures at a more convenient stacked height that is closer to the performer's ear level. In the vertical orientation, 2 SB218s provide a good footprint for stacking up to 3 ARCS.

Note: When ARCS is stacked on top of a 2 high horizontal stack of SB218 subwoofers, the overall height is 1.92 meters. When ARCS is stacked on top of SB218s oriented vertically, the overall height is 2.12 meters.

Note: It is recommended that ARCOUPL bars are used for all stacked installations in order to provide improved physical stability of the stacked ARCS system.



Figure 30: Stacked ARCS Side-fill (3 x ARCS, 1 x SB218) plus stereo front-fill system.



Figure 31: Flown ARCS Sidefill (2+2 ARCS per side) plus offstage fill system.

4.6 COMPLEMENTARY FILL APPLICATIONS

For large-scale applications, typically where V-DOSC or dV-DOSC are used as the main L/R FOH system, ARCS can be used for center-fill (flown or stacked), stereo front-fill, offstage fill or delay system applications. The number of potential uses for ARCS as a fill enclosure is only limited by your imagination. The following recommendations give some commonly-used examples. In all cases, proper time alignment of fill systems with respect to the main L/R FOH system is essential for obtaining optimum results. Similarly, pre-delay to time align the overall sound reinforcement system (main L/R plus fill systems) with the energy generated on stage is also an important consideration, particularly for the first 10 rows of the audience. SMAART, SPECTRAFOO or WINMLS are cost-effective measurement tools for performing time alignment that are recommended for this purpose.



Figure 32: Stereo in-fill plus side fill configuration



Figure 33: Distributed ARCS fill application (3 clusters of 4 x ARCS in an LCR configuration)

4.6.1 FLOWN/STACKED CENTRE FILL

Due to its compact size, modular horizontal coverage and generous asymmetrical vertical coverage, ARCS is highly suitable for center fill applications in theatre or for concert sound reinforcement when the stage is wide and main left/right array separation is more than 20 meters. An inverted center cluster array of 4-6 ARCS enclosures is very effective in these situations - the number of enclosures required depends on the horizontal coverage requirements (which in turn depends on the separation between main left/right arrays and how the main arrays are focused in the near field). The trim height and tilt of the ARCS center fill array depends on the closest distance to be covered which is in turn determined by the distance to the first rows of the audience area. L-ACOUSTICS' ARRAY or SOUNDVISION software is very useful for predicting vertical coverage requirements (see Sections 4.2 and 4.3), allowing the sound designer to quickly determine the necessary trim height and ARCS array tilt angle. Once rigging parameters are determined, the ARCS Rigging Reference Chart in Section 5 allows for efficient installation.



Figure 34: Flown ARCS center cluster (dV-DOSC L/R FOH)

As an alternative to flown center fill, ARCS can be stacked on top of a central line array of SB218 subwoofers (or any other object of suitable height) provided that the height of the HF section is suitable for audience coverage. Typically, a stacking height of at least 2 meters is recommended and ARCS should be inverted so that HF energy is projected down into the audience. However, clearance under the stage lip and audience sightlines are often important considerations for stacked center fill. If sufficient height cannot be obtained then ARCS can be used in the horizontal orientation as a distributed front fill system.



Figure 35: Stacked ARCS center fill

4.6.2 STACKED STEREO INFILL

Stacked stereo infill systems can be implemented using ARCS enclosures either located onstage or stacked on top of L/R subwoofer arrays. It is always a good idea to keep ARCS physically as close as possible to the subwoofers in order to improve sonic integration between the fill system and the subwoofers plus to reduce proximity effects for the audience located close to the subwoofers. For smaller set designs, it can also be an option to place stereo front-fill ARCS close to the subwoofers employed for onstage side-fill monitors. As for stacked center fill applications, the height of the HF section should be optimized to suit the audience seating area with special attention paid to the first few rows. Typically, a stacking height of at least 2 meters is recommended and ARCS should be inverted so that HF energy is projected down into the audience. If possible, use distance-attenuation loss to your advantage and try to move ARCS as far upstage as possible in order to reduce the increase in SPL over the first few rows relative to the audience further back in the coverage region.

For stereo front fill applications 4 ARCS enclosures provide 90 degree horizontal coverage and thus provide a good match to the coverage of the main V-DOSC arrays.



Figure 36: Stacked stereo infill (V-DOSC, dV-DOSC L/R FOH)

Single ARCS enclosures can also be used in the horizontal orientation for stereo or distributed front fill. In this case, the central axis of the loudspeaker should be aimed towards the rearmost part of the audience area to be covered. Typically, this means that ARCS will require rear blocking so that the enclosure points down into the audience slightly. In the horizontal orientation, coverage is 60° (asymmetrical) and normally ARCS is oriented with the 40° angle directed onstage (i.e., toed inwards with the logos of the left and right enclosures oriented in the offstage direction).



Figure 37: Stacked stereo infill (ARCS plus SB218 subwoofer)

4.6.3 OFFSTAGE FILL

When the horizontal coverage of the main left/right arrays is not sufficient to cover the entire audience area, single or double row ARCS arrays are effective for offstage fill. Typically, throw distance requirements are shorter and vertical coverage angles are greater making ARCS a good solution for this application. OEM factory presets for ARCS have been specifically engineered to provide a sonic signature that is compatible with V-DOSC and the modular horizontal coverage of ARCS allows for precise focus of energy in the areas where offstage coverage is required. ARRAY or SOUNDVISION software provide useful tools for examining the vertical section cutview to determine ARCS array trim height and overall tilt, while the horizontal V-DOSC isocontour is effective in determining the number of ARCS enclosures required for achieving the desired horizontal coverage plus for examining physical array location and aiming relative to the main V-DOSC arrays. Since a reduced amount of low frequency energy is generated (compared to when V-DOSC is used for offstage fill), the ARCS array can be physically located closer to the main V-DOSC arrays than the normally recommended 6-7 meters without introducing low frequency interaction problems.

Note: Time alignment of complementary fill systems with the main left/right arrays is necessary in order to achieve optimum results. Placing your measurement microphone in a representative location where the fill and main system coverage overlaps generally provides a good reference point for time alignment.



Figure 38 : ARCS Offstage Fill Plus Side Fill Example

4.7 DELAY SYSTEMS

ARCS can be used as a delay system for large audience areas - oriented either horizontally or vertically according to the coverage requirements. The excellent longthrow capability of V-DOSC oftentimes eliminates the need for a delay system, however, some external conditions such as physical obstacles, wind, sound wave refraction due to temperature and humidity gradients or very large distances (> 150 m) may create the need for a delay system (typically for open-air applications).

The use and tuning of delay systems in open-air situations is not straightforward since the correct delay time setting is typically valid only over a limited area and there are also effects of wind, temperature and humidity to consider. However, there are a few principles that should be applied when installing delay systems:

1) Over-delaying up to 15 ms is acceptable due to the Haas effect. Greater than 15 ms is not acceptable since the delayed sound will be perceived as an echo behind the main signal. Time alignment of delays should be made using a measurement point on the axis of the reference source and the delayed source. If the delay time setting is such that the two sound waves arrive at the same time on-axis, the reference source will be slightly ahead of the delayed source at any other location off-axis. For some applications (speech), it is advised to under-delay in order to optimize the off-axis intelligibility and clarity behind the delayed system (i.e., closer to the stage).

2) Spread different sources, with different delayed waves, instead of grouping them in a single location. This allows for broader coverage by the delayed sources and produces more homogeneous SPL over the delay-covered area.

3) Distributed delay positions should be along a circular arc of constant radius, centered at the stage.

Time domain-based measurement equipment is essential for setting delay times (for example, MLSAA, WINMLS, TEF, SMAART or SPECTRAFOO). Alternatively, Bushnell Yardage Pro rangefinder binoculars can provide a good starting point by simply measuring the distance from the delay location to the main system. For delay system design, ARRAY software can be used to provide a quick reference, i.e., V-DOSC can be deliberately focused to provide a 10-20 meter overlap with the coverage provided by the delay system. The ARRAY software then gives an indication as to physical delay tower locations and required time delays.

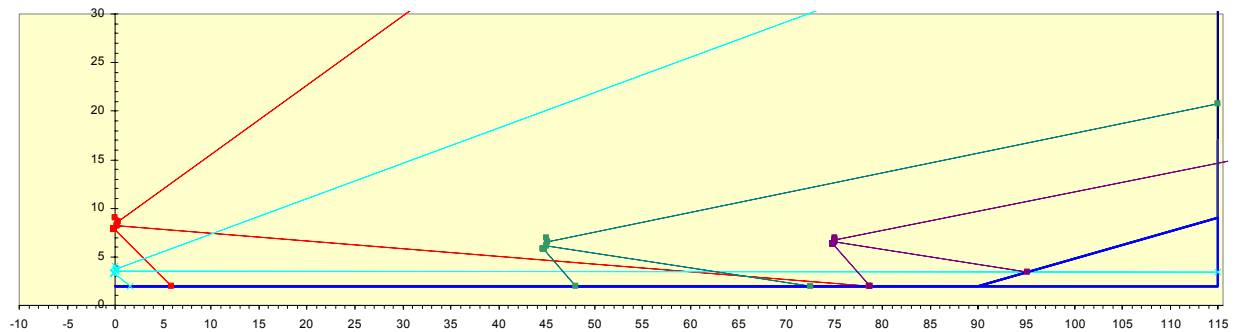

Figure 39: ARRAY cutview simulation of an ARCS FOH system with delays. The main L/R system consists of 8-10 ARCS per side in a double row configuration with 4 ARCS per side ground stacked for stereo infill. Delay rings are located at 45 and 75 meters and the exact number of delay positions per ring will depend on the plan view of the audience and the amount of horizontal coverage required.

4.8 USING ARCS WITH SUBWOOFERS

For music applications, ARCS should be used with SB118, SB218 or dV-SUB subwoofers while for speech, ARCS can be operated full range in 2-way mode and subwoofers are not necessary. As a guideline, typically one SB218 or dV-SUB subwoofer per pair of ARCS will provide sufficient output (2:1 ARCS:Subwoofer ratio) or a 1:1 ARCS:SB118 ratio. Issues involved in effectively using ARCS with subwoofers are discussed below and as a reference, L-ACOUSTICS subwoofer specifications are summarized in Table 11 and Fig 14.

Table 11: L-ACOUSTICS Subwoofer Specification Summary

| L-ACOUSTICS SUB MODEL | Freq Resp (+/- 3 dB) | Usable LF (-10 dB) | Sensitivity (1W / 1m) | RMS Voltage | POWER (cont) | POWER (peak) | MAX SPL (cont) | MAX SPL (peak) | REC'D AMP | LOAD (ohms) |
|--------------------------|-------------------------|-----------------------|--------------------------|----------------|-----------------|-----------------|-------------------|-------------------|--------------|----------------|
| SB115 | 45 - 100 Hz | 40 Hz | 94 | 45 | 250 W | 1000 W | 120 dB | 126 dB | 500 W | 8 |
| SB118 | 35 - 100 Hz | 32 Hz | 97 | 70 | 600 W | 2400 W | 125 dB | 131 dB | 1200 W | 8 |
| SB218 | 28 - 140 Hz | 25 Hz | 100.5 | 68 | 1100 W | 4400 W | 130 dB | 136 dB | 2200 W | 4 |
| dV-SUB | 40 - 200 Hz | 35 Hz | 104.5 | 57 | 1200 W | 4800 W | 133 dB | 139 dB | 2400 W | 2.7 |

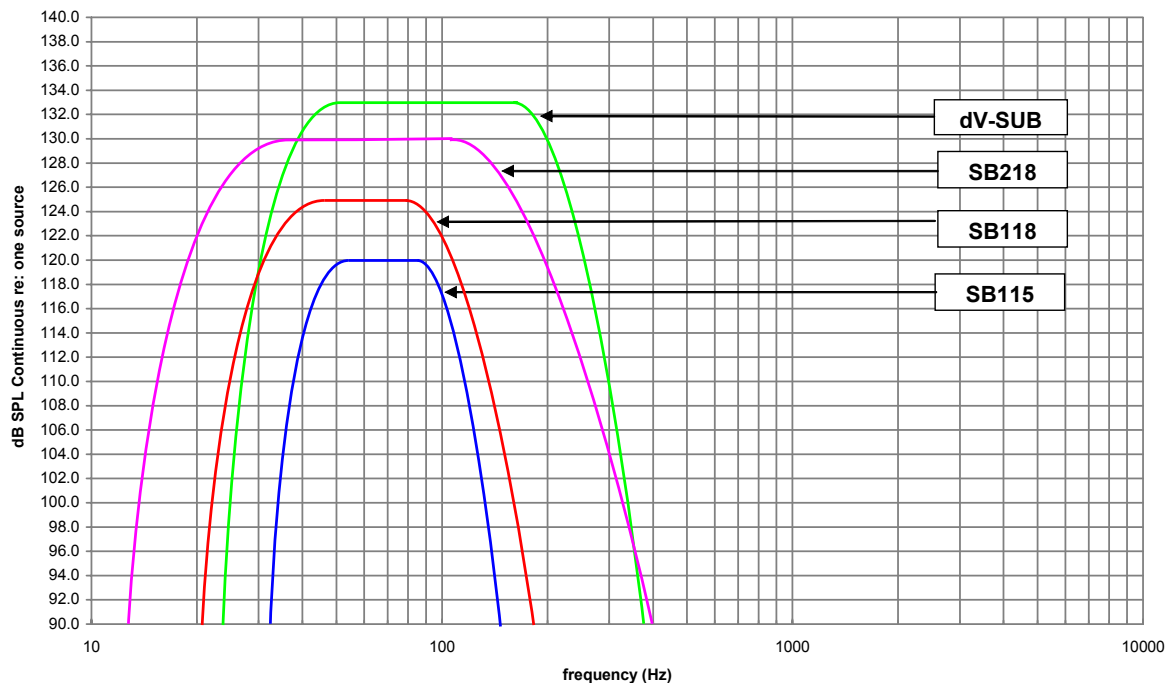

Figure 40: L-ACOUSTICS Subwoofer Continuous Unweighted SPL Comparison

a) Combining ARCS With Subwoofers

In this section, we present techniques for optimizing the coupling between an ARCS array and subwoofers. Two cases can be considered: ground stacked systems where ARCS and subwoofers are closely coupled; and a separate flown ARCS array with ground stacked subwoofers. For both cases, processing will depend on the intended purpose of the subwoofers, i.e., in some applications, subwoofers are used as an effect and are not driven with the same signal as the main ARCS system (separate auxiliary send from the console) while in other cases, the subwoofers are used as a low frequency extension of the array and are driven with the same signal in 3-way mode.

An ARCS array is capable of radiating frequencies down to 40 Hz at high level and for standard 2W presets a 40 Hz, 24 dB per octave slope Linkwitz Riley (LR24) high pass filter is employed with additional low frequency shelving equalization. When adding subwoofers to the system, part of the frequency range can overlap resulting in the potential for interference due to the phase shift of

overlapping crossover filters (depending on the selected preset and how the subwoofers are driven). Techniques for controlling this interference and maximizing the combined response of low and sub channels are discussed below.

In general terms:

3W presets have an 80 Hz LR24 low pass filter for the subwoofers with a complimentary 80 Hz LR24 high pass filter for the ARCS low section. These presets are recommended for either stacked or flown ARCS/ground stacked subwoofer applications and are suitable for either sub drive via aux send or 3-way mode.

3WX presets have an 80 Hz LR24 low pass filter for the subwoofers and an overlapping 40 Hz LR24 high pass filter for the ARCS low section (plus low frequency shelving equalization). Due to the overlap in the operating bandwidths of the sub and low sections, sub polarity may have to be adjusted depending on how the subs are driven: sub polarity = positive for sub drive via aux send, sub polarity = negative for sub drive in 3-way mode.

Table 12: Subwoofer and Low Section Processing for ARCS 3-Way Presets

| PRESET TYPE | SUBWOOFER DRIVE | SUBWOOFER BANDPASS | ARCS LOW BANDPASS | SUBWOOFER POLARITY |
|--------------------|------------------------|---------------------------|--------------------------|---------------------------|
| 3W | 3-way mode* | 25-80 Hz | 80 – 800 Hz | Positive |
| 3W | Separate aux drive** | 25-80 Hz | 80 – 800 Hz | Positive |
| 3WX | 3-way mode | 25-80 Hz | 40 – 800 Hz | Negative |
| 3WX | Separate aux drive | 25-80 Hz | 40 – 800 Hz | Positive |

* 3-way mode = same signal sent to ARCS array and subwoofers

** Separate aux drive = sub signal is independent (not sent to ARCS array)

b) Ground Stacked Systems

For ground stacked systems, ARCS and SB218 or dV-SUB subwoofers are physically close to each other and time alignment is simplified throughout the entire audience area since there are no arrival time differences between the flown ARCS array versus ground stacked subwoofers. Typically, 3W presets are used for ground stacked configurations in either 3-way mode or with separate aux drive (although 3WX presets can also be used). Please refer to Table 12 for guidelines concerning subwoofer polarity depending on the selected preset and how subwoofers are processed.

c) Separate Flown ARCS Array with Ground Stacked Subwoofers

For a separate flown ARCS array with ground stacked subwoofers, time alignment of subwoofers is required due to the geometric path difference between the two systems. This is illustrated in Figure 20, where the distance from the measurement microphone position to the subwoofers is d_{SUB} while the distance to the flown ARCS system: $d_{ARCS} = d_{SUB} + \text{PATH DIFFERENCE}$. Delaying the subwoofers by the geometric path difference will time align the subwoofers at the reference position.

Note: Selection of the reference position for time alignment is always a compromise since the geometrical path difference will vary with position.

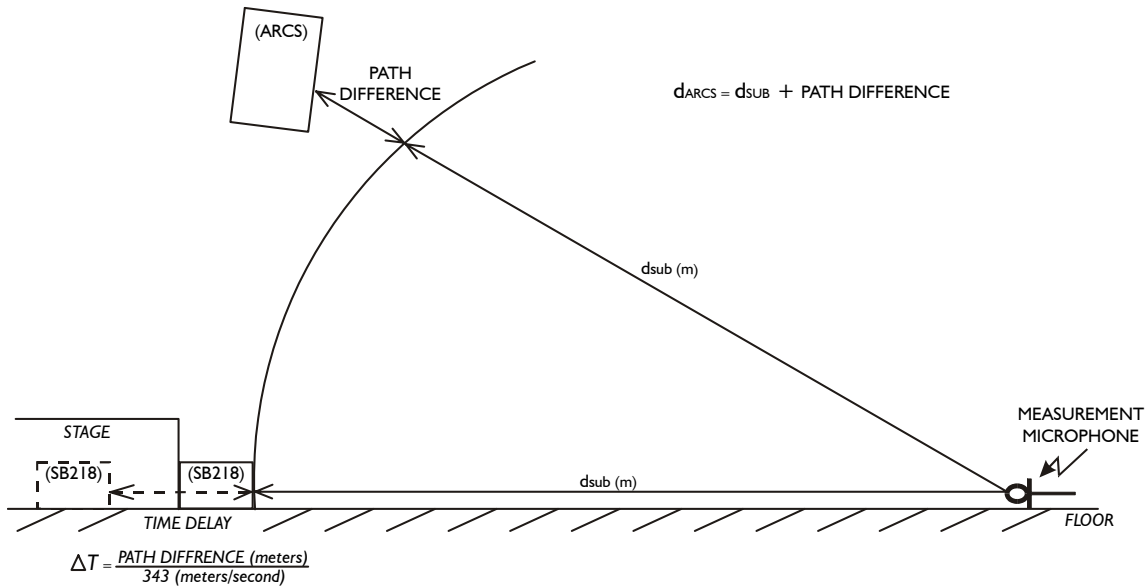

Figure 41: Illustration of subwoofer time alignment

In most cases, 3W presets are used for flown ARCS and ground stacked subwoofer configurations in (3-way mode or with separate aux drive for the subwoofers) since the subwoofers are always used with positive polarity and this helps to simplify installation and system tuning. If more low frequency energy is desired from the flown ARCS system, 3WX presets can be used with reference to Table 12 for guidelines concerning subwoofer polarity depending on how subwoofers are processed.

5. INSTALLATION PROCEDURES

WARNING: NOT FOLLOWING THE RIGGING PROCEDURES OUTLINED BELOW MAY RESULT IN A SERIOUS SAFETY HAZARD.

5.1 INSTALLATION OF A SINGLE ROW FLOWN SYSTEM

Locate all ARCS enclosures, side-by-side, at the location where they are to be rigged. For most flown applications, the 40 degree vertical coverage angle will be directed downwards. This means that when flown, the rear connector jack plates will be oriented downwards and the front L-ACOUSTICS logos will be up. Check that all ARCS enclosures are physically oriented in the desired manner.

Lift the enclosures to a vertical (standing) position by using the handles located on the top (or bottom) of each ARCS enclosure. Array the enclosures in a tightly-wrapped configuration (i.e., wall-to-wall) and remove the front dollies. When removing the O-ring spring pins from the positioning studs, watch your fingers! The feeling is similar to a mouse trap...

Position the ARCS enclosures side-by-side so that the integral flying rails are aligned (this is easier if you are on a flat surface). Use two coupling bars (ARCOUPL) per two cabinets (top and bottom) to mechanically join adjacent ARCS enclosures. Unlock and remove one shackle to free one end of each coupling bar (typically the front shackle). Slide two ARCOUPL bars into the corresponding rails, between *each* pair of adjacent enclosures - one top, one bottom. Carefully place, lock and tighten the end shackles to secure the coupling bars. Once all ARCS enclosures of the array have been mechanically coupled together, top and bottom, the array is built.

Always install two ARCOUPL coupling bars between adjacent enclosures (top and bottom)

To fly an array of 2 or 4 ARCS enclosures, one BUMP3 is required. To fly an array of 1, 3, 5, 6, 7 or 8 ARCS enclosures, two BUMP3 and one LIFTBAR are required.

Each BUMP3 is designed to work as an assembly with one ARCOUPL. To construct a BUMP3 assembly, remove the two end shackles from an ARCOUPL and align the ARCOUPL and BUMP3 so that their end holes are aligned. Secure the ARCOUPL (rear end only) with the locking nut and bolt assembly, ensuring that the cotter pin safety is installed.

Note: With reference to the ARCS rigging reference chart, the serial number plate acts as a reference for installing BUMP3, i.e. the serial number plate should be oriented towards the front of the array.

Once the rear connection between the BUMP3 and ARCOUPL is assembled, slide the ARCOUPL into the corresponding upper rails of the ARCS enclosures from the rear. Lower the BUMP3 and align its front hole with the front hole of the ARCOUPL. Align the front holes on ARCOUPL and BUMP3 and place the pierced bolt into position to join the two assemblies. Install then tighten the nut until the security hole in the bolt is accessible. Lock the nut into position by sliding the spring pin (cotter pin) into the security hole.

With reference to the ARCS Rigging Reference Chart, place the main BUMP3 shackle(s) in the desired hole of the BUMP3 and tighten securely.

For 2 or 4 element ARCS arrays, at this point, the array is ready to be flown.

For larger arrays, 2 or more BUMP3 are required and should be placed in such a way as to provide equal load distribution. For example, for a single row 6 element ARCS array, two BUMP3 will be placed between enclosures 2 & 3 and 4 & 5 and a LIFTBAR used between the two BUMP3. For a double row 8 element ARCS array, BUMP3 will be placed between enclosures 1 & 2 and 3 & 4 on the top row and a LIFTBAR used between the two BUMP3. When more than 8 ARCS enclosures are to be flown, it is advisable to use one BUMP3 per four ARCS enclosures (vertical or horizontal) as a guideline.

Always consult a certified rigger if you have any questions regarding safe rigging practice.



(1) ARCS plus required accessories for flying a single row of 4 enclosures

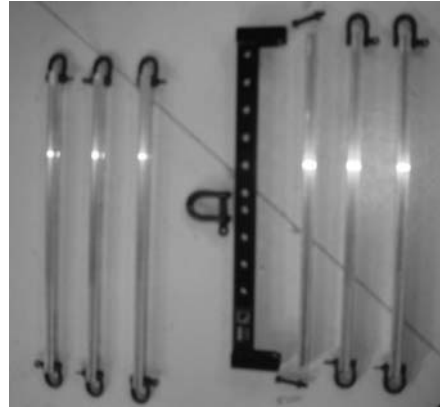

(2) Close up detail of rigging accessories (6 ARCOUPL, 1 BUMP3 plus shackles)



(3) Enclosures located in position and in the desired orientation (refer to rear jack plates – when facing downwards, -40 / +20 deg coverage is obtained)



(4) Front dolleys removed (note: logos oriented upwards indicate that ARCS are inverted for -40 / +20 deg coverage)



(5) Front shackle removed from ARCOUPL



(6) ARCOUPL slides in from the rear of the array (two required, top and bottom)

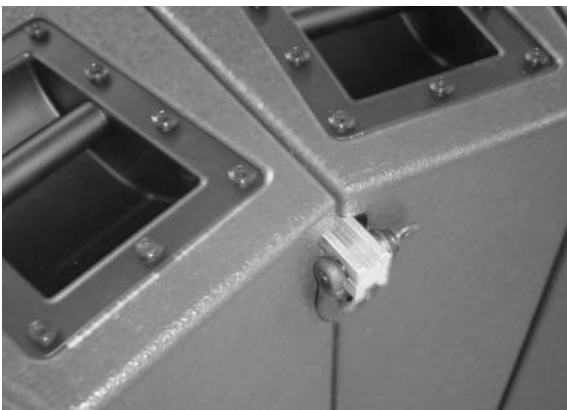

(7) Rear ARCOUPL shackle detail



(8) Front shackle secures ARCOUPL



(9) BUMP3 close up detail. Serial number plate should be oriented towards the front of the array.



(10) ARCOUPL attached to the main body of the LIFTBAR at the rear



(11) ARCOUPL secured using a locking nut and bolt assembly with cotter pin safety



(12) BUMP3 assembly slides into position from the rear



(13) Front locking nut and bolt assembly installed with safety, pick point selected on BUMP3



(14) The final flow assembly (refer to the Rigging Reference Chart for hole selection to provide the desired tilt angle for the array)

Figure 42: Rigging Procedure for a 4 Enclosure ARCS Array



(1) 2 x BUMP3 and 1 x LIFTBAR required for rigging 1, 3 or 5 ARCS



(2) 2 x ARCOUPL installed on the bottom of the array, 2 x BUMP3 installed on top



(3) The final flown assembly (refer to the Rigging Reference Chart for hole selection to provide the desired tilt angle for the array)

Figure 43: Rigging Procedure for a 3 Enclosure ARCS Array

5.2 INSTALLATION OF A DOUBLE ROW FLOWN SYSTEM

Two single row ARCS arrays can be combined into a double row array to increase the output sound pressure level. Low frequency loudspeakers are coupled by arraying the enclosures bottom-to-bottom with the connector plates of upper row enclosures oriented upwards (front logo down) and the connector plates of lower row enclosures oriented downwards (front logo up).

- * First assemble and fly the upper row as described previously in Section 5.1
- * Position the bottom row of enclosures directly underneath the first row of the array
- * Assemble the bottom row of enclosures together using ARCOUPL (do not use the BUMP3 flying element for the bottom row)
- * Lower the top row into position and physically attach the top row to the bottom row using the ARCSTRAP adapter (front and rear).
- * The two rows are now physically attached to each other and the array can be flown.

Alternatively, the double row of ARCS enclosures can be stacked prior to assembly (as shown in the rigging procedure illustrated below).

Note: For a 2 x 2 element ARCS array, only one BUMP3 is necessary. For a 2 x 3 element ARCS array, one LIFTBAR should be used along with two BUMP3 (placed between enclosures 1 & 2 and 2 & 3). For a 2 x 4 element ARCS array, one LIFTBAR should be used along with two BUMP3 placed between enclosures 1 & 2 and 3 & 4. When more enclosures are to be flown, employ one BUMP3 per four ARCS enclosures (horizontally or vertically).



(1) ARCS plus accessories for flying a double row of 4+4. Note: logo-to-logo orientation of enclosures.



(2) Rigging accessories (10 ARCOUPL, 2 BUMP3, 1 LIFTBAR, 6 ARCSTRAP plus shackles required)

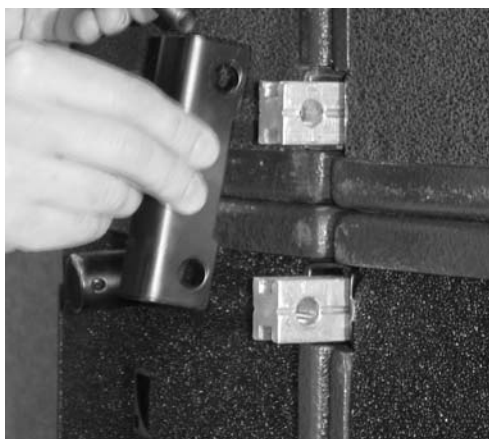

(3) ARCSTRAP attached between the middle pair of ARCOUPL (front and rear)

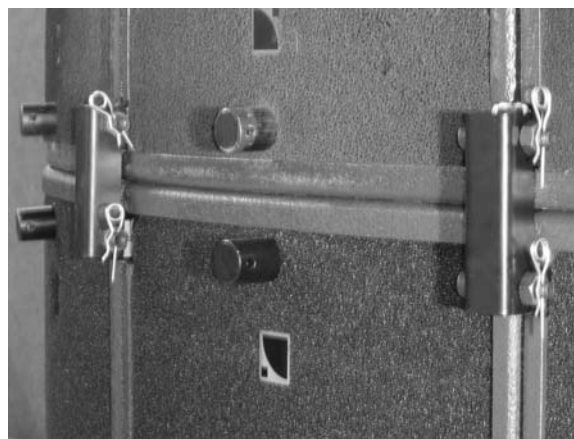

(4) ARCSTRAP secured using a locking nut and bolt assembly with cotter pin safety



(5) Front detail of ARCSTRAP attachment



(6) Rear detail of ARCSTRAP attachment



(7) BUMP3 slides into position from the rear



(8) 2 x BUMP3 required



(9) LIFTBAR attached to 2 x BUMP3 (refer to Rigging Reference Chart for hole selection)

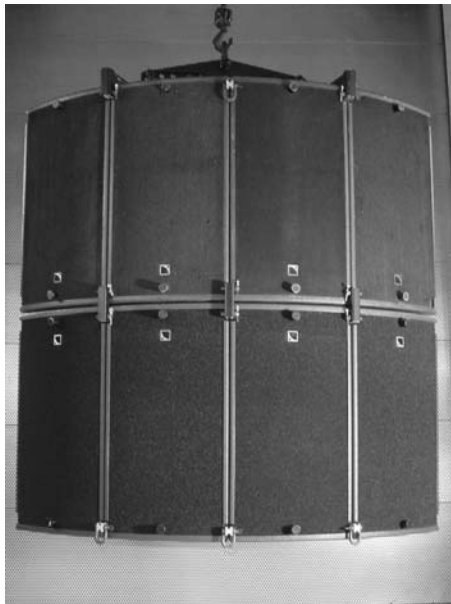

(10) The final flown assembly (front detail)



(11) The final flown assembly (rear detail)

Figure 44: Rigging procedure for a double row (4+4) enclosure ARCS array

5.3 ARCBUMP INSTALLATION

When installing ARCS horizontally, the horizontal coverage is not symmetrical and when used as a stereo pair, in most cases, it is preferable to have the 40° coverage angle directed inwards for both sides. For offstage fill applications the 40° coverage angle is normally oriented in the offstage direction.

For rigging up to 3 ARCS enclosures horizontally, single point hangs can be performed using the rigging points available on the central spreader bar section of ARCBUMP. For flying 4 ARCS enclosures horizontally, a bridled hang should be performed using the exterior points on the sides of the ARCBUMP frame. Safety steels must be employed for all flown horizontal applications. These safety steels are attached between all front and rear ARCOUPL attachment shackles, including the ARCOUPL bars that are used to attach ARCBUMP.

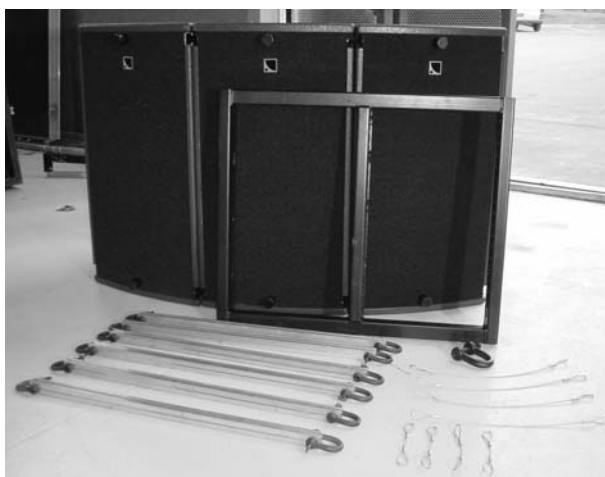

(1) ARCS plus required accessories for flying 3 enclosures horizontally.



(2) Safety steels attached between ARCOUPL shackles (front and rear, top and bottom)



(3) Safety steel detail (top)



(4) Safety steel detail (top and bottom)



(5) Safety steel detail (front, top and bottom)



(6) ARCBUMP attached to the array using 2 x ARCOUPL (top and bottom)



(7) Safety steels are used to secure ARCBUMP to the array (front and rear, top and bottom)



(8) Front view



(9) Side view (note: shackle attached to central spreader bar section for single point hang)



(10) Rear view

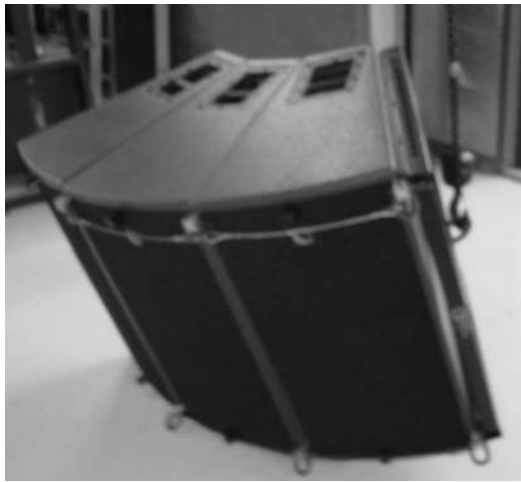

(11) Motor attached to pick point – start to raise the array

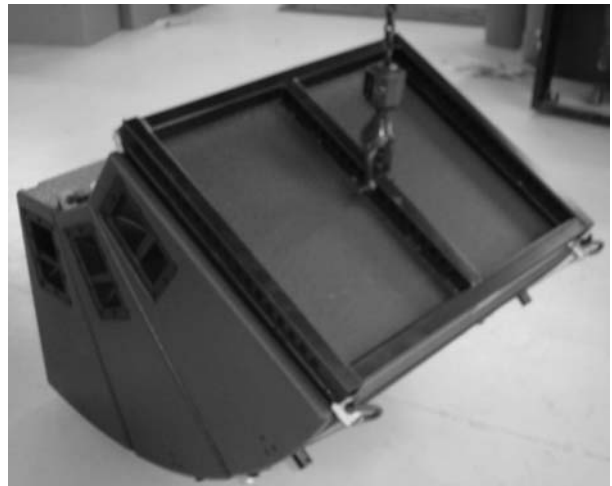

(12) As the array is raised, use the rear handles to rotate the system into the correct orientation



(13) The final flown assembly (front view)



(14) The final flown assembly (rear view)

Figure 45: ARCBUMP rigging procedure for a 3 enclosure horizontal ARCS array

**Table 13: ARCBUMP Pick Point Hole Number versus Tilt Angle for 2, 3 or 4 ARCS
(hole #1 = rear pick point, ARCBUMP serial number plate towards the front)**

| Hole Number | 2 ARCS Tilt Angle (deg) | 3 ARCS Tilt Angle (deg) | 4 ARCS * Tilt Angle (deg) |
|-------------|-------------------------|-------------------------|---------------------------|
| 1 | -35 | -15.5 | -1 |
| 2 | -31 | -11 | 2 |
| 3 | -26.5 | -7.5 | 6 |
| 4 | -22 | -3.5 | 9 |
| 5 | -16.5 | -0.5 | 12.5 |
| 6 | -11.5 | 4 | 15 |
| 7 | -4 | 7.5 | 18.5 |
| 8 | 1.5 | 12 | 21 |
| 9 | 7.5 | 16 | 24 |
| 10 | 13 | 18.5 | 27 |
| 11 | 18 | 22.5 | 29 |
| 12 | 23 | 27 | 31.5 |
| 13 | 27.5 | 30 | 34 |
| 14 | 32 | 33 | 36 |
| 15 | 35.5 | 36 | 38 |
| 16 | 39 | 38 | 39.5 |
| 17 | 42 | 41 | 41 |
| 18 | 45 | 43 | 44.5 |

* For flying 4 ARCS enclosures horizontally, a bridled hang should be performed using the exterior points on the sides of the ARCBUMP frame.

* Bridled hangs are also recommended for 1-3 ARCS arrays in order to compensate for ARCS enclosure center of gravity offset in the horizontal plane.

5.4 SAFETY RULES

Always consult a certified rigger if you have any questions regarding safe rigging practice.

L-ACOUSTICS recommends the use of safety steels at all times.

Always install two ARCOUPL coupling bars between adjacent enclosures (top and bottom). This applies to either flown or stacked installations.

Single point hangs can be performed using the rigging points available on the central spreader bar section of ARCBUMP for rigging up to 3 ARCS enclosures horizontally. For flying 4 ARCS enclosures horizontally, a bridled hang should be performed using the exterior points on the sides of the ARCBUMP frame. Safety steels must be employed for all flown horizontal applications using ARCBUMP.



L-ACOUSTICS ARCS RIGGING REFERENCE CHART

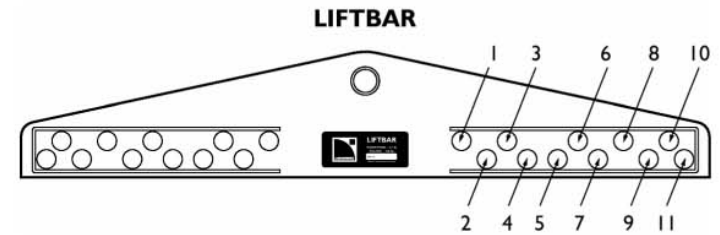
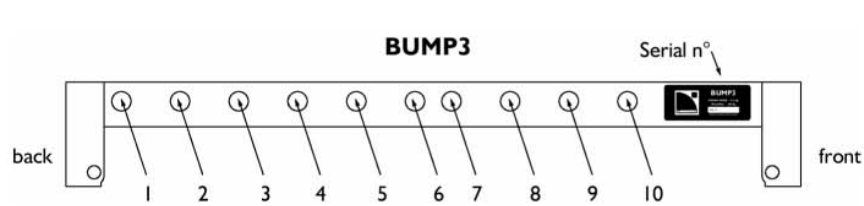

| 1 ARCS | | 2 ARCS | | 3 ARCS | | 4 ARCS | | 6 ARCS | | 4 ARCS (2x2) | | 6 ARCS (2x3) | | 8 ARCS (2x4) | | |
|------------|--------------|----------------------|--------------|----------------------|--------------|----------------------|--------------|----------------------|--------------|----------------------|--------------|----------------------|--------------|----------------------|--------------|----------------------|
| BUMP3 hole | LIFTBAR hole | Tilt angle (degrees) | LIFTBAR hole | Tilt angle (degrees) | LIFTBAR hole | Tilt angle (degrees) | LIFTBAR hole | Tilt angle (degrees) | LIFTBAR hole | Tilt angle (degrees) | LIFTBAR hole | Tilt angle (degrees) | LIFTBAR hole | Tilt angle (degrees) | LIFTBAR hole | Tilt angle (degrees) |
| 1 | | | | -35,0° | | | | -28,5° | 6 | -16,0° | | | | | | |
| 2 | 2 | -35,0° | | -29,0° | 2 | -27,5° | | -22,5° | 7 | -5,5° | | | | | | |
| 3 | 2 | -29,0° | | -23,0° | 2 | -21,5° | | -15,5° | 8 | -3,5° | | | | | | |
| 4 | 3 | -20,5° | | -16,5° | 3 | -15,0° | | -9,0° | 9 | +3,0° | | | 3 | -8,5° | | |
| 5 | 3 | -14,0° | | -9,0° | 3 | -8,0° | | -2,0° | 10 | +8,5° | | -6,0° | 3 | -4,5° | 10 | -4,5° |
| 6 | 4 | -6,0° | | -2,0° | 4 | -1,0° | | +5,5° | 11 | +12,0° | | -1,0° | 4 | -1,0° | 11 | -2,0° |
| 7 | 4 | -2,0° | | +2,5° | 4 | +2,5° | | +9,5° | | | | +1,5° | 4 | +1,5° | | |
| 8 | 5 | +6,5° | | +9,5° | 5 | +10,5° | | +17,0° | | | | +5,5° | 5 | +6,0° | | |
| 9 | 5 | +15,0° | | +17,0° | 5 | +17,0° | | +24,5° | | | | | | | | |
| 10 | 6 | +21,5° | | +23,5° | 6 | +28,5° | | +30,0° | | | | | | | | |

= NOT APPLICABLE (OR NOT TABULATED)

(NEGATIVE ANGLES = DOWN, POSITIVE ANGLES = UP)

Table 14: ARCS Rigging Reference Chart

6 ARCS SYSTEM OPERATION

Connect program signal lines (L/R outputs from a mixing console, for example) to the A and B channel inputs of the digital signal processor (XTA DP224, DP226 or BSS 334, 336, 366).

With reference to the output channel assignments given in the Preset Description sheets (see also Figures 5-9), connect the outputs of the DSP unit to the corresponding amplifier inputs (directly or via your signal distribution / return snake multicore system).

For 6 channel units (XTA DP226 or BSS 336, 366) outputs 1, 2, 3 correspond to SUB, ARCS LOW, ARCS HIGH for input A while output channels 4, 5, 6 correspond to SUB, ARCS LOW, ARCS HIGH for input B.

Power up the DSP unit and select the appropriate preset for 2-way or 3-way operation (LO or HI shelving equalization for the HF section) plus SB218 or dV-SUB subwoofers (3-way mode).

Perform the following steps as a system check:

- 1) turn down the level of all amplifier channels before turning the amplifiers on
- 2) un-mute the HIGH crossover channel
- 3) send a pink noise signal to the crossover
- 4) turn up the level of each HIGH amplifier channel individually and check that this provides the expected frequency band in the expected loudspeaker component. Test each HIGH amplifier channel individually until all HIGH amplifier channels have been tested.
- 5) mute the HIGH crossover channel
- 6) repeat steps 2-5 for LOW and SUB channels
- 7) turn off the pink noise

Set all amplifier output levels to 0 dB gain

Un-mute all crossover output channels and the system is ready for use.

Remember the old saying: "amps on last, amps off first" in order to avoid component damage due to power on/off transients.

6.1 RECOMMENDED MAINTENANCE PROCEDURES

a) HF Diaphragm Replacement

To access the HF compression driver for service, there is no need to remove the compression driver from the enclosure (a fairly complex operation). Simply demount the rear jack plate for direct access to the compression driver.

Unscrew the back cover of the compression driver to obtain access to the diaphragm. Remove the damaged diaphragm and before installing the replacement diaphragm ensure that the voice coil gap is free from any metallic particles, dirt or other debris by using 2-sided tape and acetone, if necessary, to thoroughly clean out the gap.

After installing the replacement diaphragm, apply a low level, low frequency sine wave sweep (for example: 4 volts from 100 Hz - 1 kHz) to ensure that the diaphragm is properly centered in the gap before reinstalling the compression driver back cover. Make sure all compression driver diaphragm and back cover mount screws are securely fastened (loctite is optional but recommended).

As a final check apply a high level sine sweep over the HF compression driver's operating bandwidth (for example: 13 volts from 1 kHz to 18 kHz).

Following service, the damaged compression driver diaphragm should be returned to your distributor or directly to L-ACOUSTICS for warranty examination.

b) LF Service

The 15" loudspeaker cone assembly is not field-serviceable. For field service, the damaged 15" loudspeaker should be removed and replaced. To remove the front grille, lift the edges of the acoustic foam and remove the screws. Screws can be found where the edges of the foam are not glued to the grille - there is no need to completely remove the acoustic foam in order to remove the loudspeaker grille.

The damaged loudspeaker should be returned to your distributor or directly to the factory for warranty examination and reconing.

c) Polarity Check

Whenever a HF diaphragm or 15" loudspeaker is replaced, wiring polarity should be checked with a polarity checking device. Both LF and HF components should operate with positive polarity.

d) Periodic Check

The frequency response of the enclosure should be checked periodically to check for any deviations due to wear, shock or other damage. This should be done on an annual basis for systems not subjected to demanding use. For systems being used on a daily basis for sub hire or touring, enclosures should be checked every month (or even more frequently).

A frequency response check can be performed with a high resolution RTA (real time analyzer), or preferably using WINMLS, SMAART, SPECTRAFOO, TEF or MLSSA measurement systems. Refer to the on-axis amplitude/frequency response in order to determine if the response of your ARCS enclosure is within specification. In addition, a response sweep using a sine wave generator is useful for checking for coil rubs, buzzes, air leaks or other undesirable mechanical vibrations as part of the periodic quality control procedure.

The mechanical attachment of both low frequency and high frequency loudspeakers should be checked periodically since screws can become loose after being submitted to intense, long duration mechanical vibrations. Similarly, it is a good idea to periodically check that the high frequency diaphragm and rear cover for the compression driver are solidly attached. The quality of the contacts and locking action of the Speakon connector should also be checked periodically.

6.2 SPARE PARTS

| | |
|------------|---------------------------------|
| HP BC2I | 1.4" driver (8 ohms) |
| HS BC2I | Diaphragm for 1.4" driver |
| HP PH153 | 15" speaker (8 ohms) |
| HS PH153 | 15" recone kit |
| HR PH153 | 15" recone kit including labour |
| CM ARCS | Front foam |
| MC ARCSGRL | Front grill |
| CD COLNEO | Neoprene glue 500ML |

7 SPECIFICATIONS

| | |
|---|--|
| Frequency Response: | 63 - 18k Hz +/- 3 dB 50 - 20k Hz (-10 dB) |
| Sensitivity: (2.83 Vrms @ 1m) | LF: 98 dB SPL (63 - 800 Hz) HF: 109 dB SPL (800 - 18k Hz) |
| Nominal Impedance: | LF: 8 ohms HF: 8 ohms |
| Power Rating: | LF: 54 Vrms 375 Wrms 1500 Wpeak HF: 29 Vrms 100 Wrms 400 Wpeak |
| Amplification: | LF: 750 W minimum (8 ohms) 1500 W minimum (4 ohms) 2250 W minimum (2.7 ohms) HF: 400 W minimum (8 ohms) 800 W minimum (4 ohms) 1200 W minimum (2.7 ohms) |
| System Output: | 1 enclosure: 128 dB (continuous, unweighted, 1 m, 2WLO preset) 2 enclosures: 133 dB (continuous, unweighted, 1 m, 2WLO preset) 4 enclosures: 137 dB (continuous, unweighted, 1 m, 2WLO preset) |
| Nominal Directivity: | 22.5° horizontal (symmetrical) 60° vertical (asymmetrical: 20° down x 40° up) |
| Components: | LF: 1 x 15" weatherproof loudspeaker (bass-reflex loaded, 3" voice coil) HF: 1 x 1.4" compression driver mounted on DOSC waveguide and lens |
| Material: | Baltic birch plywood (15, 18 and 24 mm). Sealed, screwed and rabbeted angles, internally braced cabinet construction |
| Finish: | Maroon-gray |
| Grill: | Black epoxy perforated steel with acoustically transparent foam |
| Features: | Integrated flying hardware, handles |
| Dimensions : | 820 mm (Height) x 440 mm (Front) x 190 mm (Rear) x 652 mm (Depth) (32.3" x 17.3" x 7.5" x 25.7") |
| Weight: | 57 kg (125.7 lbs) |

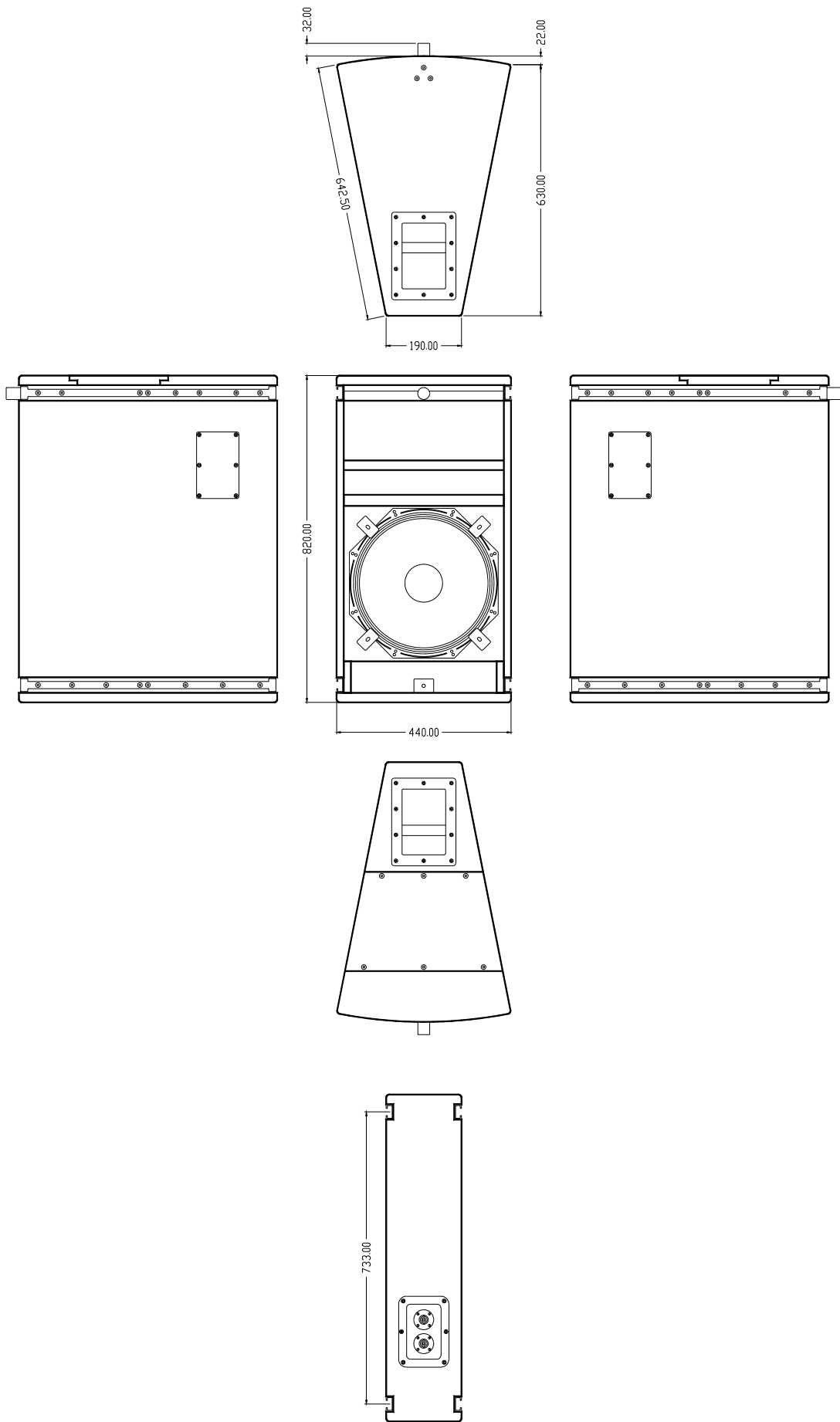

Figure 46: ARCS line drawing



DECLARATION OF CE CONFORMITY

For the product :

Catalog Item : ARCS®

Description : L-ACOUSTICS® ARCS
loudspeaker enclosure

Dimensions : 820 mm x 440 mm x 652 mm
(H x W x D)

Material : Baltic birch plywood
with internal steel bracing
and external steel rigging rails



Optional accessories :

Rigging structure – BUMP3

Rigging structure – LIFTBAR

Rigging structure – ARCBUMP

Extruded aluminum alloy bar – ARCOUPL

Rigging accessory – ARCSTRAP (Steel U-Channel)

Product Origin

Country of origin of the product : France

Country of origin for components of the product : EEC

Technical Specifications :

The ARCS loudspeaker enclosure is intended for overhead suspension vertically when using the BUMP3 and LIFTBAR rigging structures or horizontally when using the ARCBUMP rigging structure. Up to 8 ARCS loudspeakers can be suspended using 2 BUMP3 and 1 LIFTBAR. Up to 4 ARCS loudspeakers can be suspended using 1 ARCBUMP. The following chart indicates the safety factor when using the ARCS System according to the conditions described in the ARCS OPERATOR MANUAL Version 2.0 or later :

| | |
|---------------------------------|-------------------|
| ARCS | |
| Weight | 57 Kg / 126 lbm |
| WLL | 120 daN / 270 lbf |
| Ultimate Strength Safety Factor | > 10 |

L-ACOUSTICS

11, Rue Levacher - Clichy
Parc de la Fontaine de Jouvence
91402 Marcoussis - cedex
France
Tél : +33 (0) 69 63 69 63
Fax : +33 (0) 69 63 69 64
http://www.l-acoustics.com
e-mail : info@l-acoustics.com
S.A.S. au capital de 232 300 €
SIS 594 880 RCS 7049
TVA (OAT) - FR 4125194600

10/2003

DCE-ARCS - page 1/2



Standards conformity

ARCS loudspeaker enclosures are designed to be suspended using the rigging structures BUMP3 and LIFTBAR vertically.

2 or 4 ARCS can be suspended from a single rigging point using one BUMP3. 1, 3, 5, 6, 7 or 8 ARCS enclosures must be suspended from two BUMP3 and optionally using one LIFTBAR for a single rigging point.

Adjacent ARCS enclosures are securely attached to each other using 2 extruded aluminum alloy bars (ARCOUPL) in order to form a horizontal row. Up to 2 horizontal rows can be assembled using the ARCSTRAP rigging accessory. The BUMP3 rigging structure is attached between adjacent ARCS enclosures using the ARCOUPL accessory in conjunction with front and rear locking bolt assemblies. The LIFTBAR rigging structure is then attached to a pair of BUMP3 using two 22 mm diameter shackles (MAN22).

Up to 3 ARCS loudspeaker can be suspended horizontally from the ARCBUMP rigging structure using 1 rigging point. Up to 4 ARCS loudspeaker can be suspended horizontally from ARCBUMP using 2 rigging points.

L-ACOUSTICS has engineered the ARCS rigging system and its accessories using state of the art modeling and calculation software. The LIFTBAR rigging structure, the BUMP3 rigging structure, the ARCOUPL aluminum bar and the ARCSTRAP rigging accessory were also destructively tested to validate the final design using a pulling bench equipped with laboratory calibrated measuring cells.

L-ACOUSTICS hereby declares that the above product conforms to :

1. **The Machinery Directive 98/37/CE**, Part 4 : Lifting Accessories
2. **Low Voltage Directive 73/23/CE** (harmonized standard EN60065).

Established at Marcoussis, France, on the 22nd of August, 2003

Signature of L-ACOUSTICS representative :

Jacques Spillmann
Chief Engineer - Manufacturing

10/2003

DCE-ARCS - page 2/2

Figure 47: ARCS Rigging Certification



DECLARATION OF CE CONFORMITY

For the product :

Catalog Item : BUMP3

Description : Rigging structure for
L-ACOUSTICS® ARCS® loudspeaker

Dimensions : 726 mm x 40 mm x 103 mm
(L x W x H)

Material : Steel

Supplied with the following accessories :
1 x Shackle 18 mm dia. WLL 1T250 – MAN18
2 x Grade M12 Locking Bolt Assembly

Optional accessories :
Extruded aluminum alloy bar – ARCOUPL
Rigging Accessory – ARCSTRAP (Steel U-Channel)

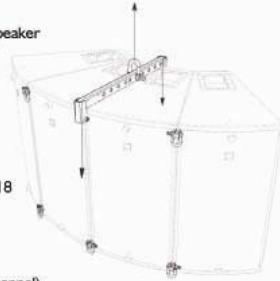

Product Origin

Country of origin of the product : France
Country of origin for components of the product : EEC

Technical Specifications :

The BUMP3 model allows for suspension of up to 4 ARCS loudspeakers using 1 rigging point. The following chart indicates the safety factor when using the BUMP3 rigging accessory according to the conditions described in the ARCS OPERATOR MANUAL Version 2.0 or later :

| | |
|---------------------------------|-------------------|
| BUMP3 | |
| Weight | 3,8 Kg / 8,4 lbm |
| WLL | 240 daN / 540 lbm |
| Ultimate Strength Safety Factor | >7 |

L-ACOUSTICS

13, Rue Lesclapart - Centre,
Parc de la Fontaine de Bouvance
91462 Marcoussis - cedex
France
Tel : +33 (0)1 69 63 69 63
Fax : +33 (0)1 69 63 69 64
http://www.l-acoustics.com
e-mail : info@l-acoustics.com
SAS au capital de 252 000 €
SIS 096 800 RCS 0947
TVA 067 - FR 411019446

10/2003

DCE-BUMP3 - page 1/2



Standards conformity

The rigging structure BUMP3 is designed for suspension of L-ACOUSTICS ARCS loudspeakers only, in accordance with published L-ACOUSTICS instructions.

2 or 4 ARCS can be suspended from a single rigging point using one BUMP3. 1, 3, 5, 6, 7 or 8 ARCS enclosures must be suspended from two BUMP3 and optionally using one LIFTBAR for a single rigging point.

Adjacent ARCS enclosures are securely attached to each other using 2 extruded aluminum alloy bars (ARCOUPL) in order to form a horizontal row. Up to 2 horizontal rows can be assembled using the ARCSTRAP rigging accessory. The BUMP3 rigging structure is attached between adjacent ARCS enclosures using the ARCOUPL accessory in conjunction with front and rear locking bolt assemblies. The LIFTBAR rigging structure is then attached to a pair of BUMP3 using two 22 mm diameter shackles (MAN22).

L-ACOUSTICS has engineered the BUMP3 rigging system and its accessories using state of the art modeling and calculation software. The BUMP3 rigging structure, the ARCOUPL aluminum bar and the ARCSTRAP steel brace were also destructively tested to validate the final design using a pulling bench equipped with laboratory calibrated measuring cells.

L-ACOUSTICS hereby declares that the above products conform to :

1. **The Machinery Directive 98/37/CE**, Part 4 : Lifting Accessories
2. **Rules for the Design of Hoisting Appliances**, European Federation of Materials Handling and Storage Equipment (FEM 1.001).

Established at Marcoussis, France, on the 22nd of August 2003

Signature of L-ACOUSTICS representative :

Jacques Spillmann
Chief Engineer - Manufacturing

10/2003

DCE-BUMP3 - page 2/2

Figure 48 : BUMP3 Rigging Certification



DECLARATION OF CE CONFORMITY

For the product :

Catalog Item : LIFTBAR

Description : Rigging structure for L-ACOUSTICS® ARCS® loudspeaker

Dimensions : 680 mm x 42 mm x 125 mm (L x W x H)

Material : Steel

Supplied with the following accessories :
1 x Shackle 18 mm dia. WLL 1T250 – MAN18
2 x Shackle 22 mm dia. WLL 2T – MAN22

Optional accessories :
Extruded aluminum allied bar – ARCOUPL
Rigging accessory – ARCSTRAP (Steel U-Channel)

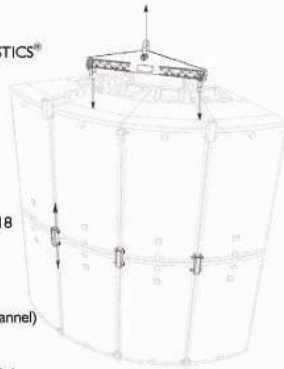

Product Origin

Country of origin of the product : France
Country of origin for components of the product : EEC

Technical Specifications :

The LIFTBAR model allows for suspension of up to 8 ARCS loudspeakers using 1 rigging point. The following chart indicates the safety factor when using the LIFTBAR accessory according to the conditions described in the ARCS OPERATOR MANUAL Version 2.0 or later :

| LIFTBAR | |
|---------------------------------|--------------------|
| Weight | 5,7 Kg / 12,6 lbm |
| WLL | 480 daN / 1079 lbm |
| Ultimate Strength Safety Factor | >7 |

L-ACOUSTICS

11, Rue Levaucher - Citrix
Parc de la Fontaine de Jouvence
91402 Marcoussis - cedex
France
Tél : +33 (0)1 69 63 49 63
Fax : +33 (0)1 69 63 49 64
http://www.l-acoustics.com
e-mail : info@l-acoustics.com
SAS au capital de 250 000 €
110 106 802 RCS 53907
TVA (n°) : FR 4131614680

10/2003

DCE-LIFTBAR - page 1/2



Standards conformity

The rigging structure LIFTBAR is designed for suspension of L-ACOUSTICS ARCS loudspeakers only, in accordance with published L-ACOUSTICS instructions.

2 or 4 ARCS can be suspended from a single rigging point using one BUMP3. 1, 3, 5, 6, 7 or 8 ARCS enclosures must be suspended from two BUMP3 and optionally using one LIFTBAR for a single rigging point.

Adjacent ARCS enclosures are securely attached to each other using 2 extruded aluminum alloy bars (ARCOUPL) in order to form a horizontal row. Up to 2 horizontal rows can be assembled using the ARCSTRAP rigging accessory. The BUMP3 rigging structure is attached between adjacent ARCS enclosures using the ARCOUPL accessory in conjunction with front and rear locking bolt assemblies. The LIFTBAR rigging structure is then attached to a pair of BUMP3 using two 22 mm diameter shackles (MAN22).

L-ACOUSTICS has engineered the LIFTBAR rigging system and its accessories using state of the art modeling and calculation software. The LIFTBAR rigging structure, the ARCOUPL aluminum bar and the ARCSTRAP rigging accessory were also destructively tested to validate the final design using a pulling bench equipped with laboratory calibrated measuring cells.

L-ACOUSTICS hereby declares that the above product conform to :

1. **The Machinery Directive 98/37/CE**, Part 4 : Lifting Accessories
2. **Rules for the Design of Hoisting Appliances**, European Federation of Materials Handling and Storage Equipment (FEM 1.001).

Established at Marcoussis, France, on the 22nd of August 2003

Signature of L-ACOUSTICS representative :

Jacques Spillmann
Chief Engineer - Manufacturing

10/2003

DCE-LIFTBAR - page 2/2

Figure 49 : LIFTBAR Rigging Certification



DECLARATION OF CE CONFORMITY

For the product :

Catalog Item : ARCSTRAP

Description : U-Channel Accessory for
L-ACOUSTICS® ARCS® System

Material : Steel (4 mm thickness)

Supplied with the following accessories :
2 x Grade M12 Locking Bolt Assembly



Product Origin

Country of origin of the product : France
Country of origin for components of the product : EEC

Technical Specifications :

The ARCSTRAP rigging accessory allows for suspension of double row ARCS configurations. The following chart indicates the safety factor when using the ARCSTRAP rigging accessory according to the conditions described in the ARCS User Manual Version 2 or later :

| ARCSTRAP | |
|---------------------------------|-------------------|
| Weight | 0,3 Kg / 0.66 lbm |
| WLL | 60 daN / 135 lbm |
| Ultimate Strength Safety Factor | > 12 |

L-ACOUSTICS
13, Rue Emacheri - Centre
Parc de la Forêt de Juvenot
91462 Marcoussis - cedex
France
Tél : +33 (0) 69 63 89 63
Fax : +33 (0) 69 63 89 64
http://www.l-acoustics.com
email : info@l-acoustics.com
SIREN : 488 548 000 RCS : 91097
TVA n°2 : FR 41335946802

10/2003

DCE-ARCSTRAP - page 1/2



Standards conformity

Adjacent ARCS enclosures are securely attached to each other using 2 extruded aluminum alloy bars (ARCOUPL) in order to form a horizontal row. Up to 2 horizontal rows can be assembled using the ARCSTRAP rigging accessory. The ARCSTRAP rigging accessory is attached to the ARCOUPL accessory using 2 x M12 locking bolt assemblies.

L-ACOUSTICS has engineered the ARCSTRAP rigging accessory using state of the art modeling and calculation software. The ARCSTRAP rigging accessory was also destructively tested to validate its final design using a pulling bench equipped with laboratory calibrated measuring cells.

L-ACOUSTICS hereby declares that the above product conforms to :

1. **The Machinery Directive 98/37/CE**, Part 4 : Lifting Accessories
2. **Rules for the Design of Hoisting Appliances**, European Federation of Materials Handling and Storage Equipment (FEM 1.001).

Established at Marcoussis, France, on the 15th of October, 2003

Signature of L-ACOUSTICS representative :

Jacques Spillmann
Chief Engineer - Manufacturing

10/2003

DCE-ARCSTRAP - page 2/2

Figure 50 : ARCSTRAP Rigging Certification



DECLARATION OF CE CONFORMITY

For the product :

Catalog Item : ARCBUMP

Description : Rigging structure for L-ACOUSTICS ARCS® loudspeaker

Dimensions : 770 mm x 645 mm x 60 mm (L x W x H)
30.3 inch x 25.4 inch x 2.4 inch

Material : Steel

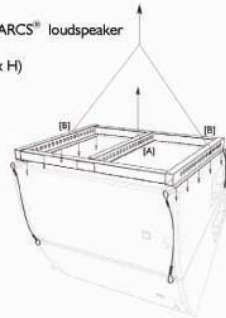

Supplied with the following accessories :

- 6 x Steel sling length 0.425 m - EL1ARCBUMP
- 6 x Steel sling length 0.155 m - EL2ARCBUMP
- 2 x Coupling bar - ARCOUPL
- 2 x dia. 18 mm shackle WLL 1T250 - MAN18

Product Origin

Country of origin of the product : France

Country of origin for components of the product : EEC

Technical Specifications :

The ARCBUMP rigging structure allows for flying of up to 3 ARCS loudspeakers from 1 rigging point on the central bar [A], or 4 ARCS loudspeakers from 2 rigging points on the side bars [B]. The following chart gives the safety factor under worst case loading conditions as specified in the ARCS OPERATOR MANUAL Version 2.0 or later :

| ARCBUMP | 1 POINT / BAR [A] | 2 POINTS / BARS [B] |
|---------------------------------|-------------------|---------------------|
| Weight | 13 Kg / 29 lbm | 13 Kg / 29 lbm |
| WLL | 180 daN / 404 lbf | 240 daN / 540 lbf |
| Ultimate Strength Safety Factor | > 12 | > 12 |

L-ACOUSTICS
 11, Rue Levallois - Citivox
 Parc des Fontaines de Bouence
 91402 Marcoussis - cedex
 France
 Tél : +33 (0) 69 63 69 63
 Fax : +33 (0) 69 63 69 64
 http://www.l-acoustics.com
 e-mail : info@l-acoustics.com
 SAS au capital de 252 300 €
 RCS 398 800 825 5095
 TVA (VAT) FR 413104680

11/2003

DCE-ARCBUMP - page 1/2



Standards conformity

The rigging structure ARCBUMP is designed for use with L-ACOUSTICS ARCS loudspeakers in accordance with published L-ACOUSTICS instructions.

Up to 3 ARCS can be installed using a single rigging point on bar [A]. Up to 4 ARCS can be installed using 2 rigging points on bar [B].

The design, testing, and quality control assurance procedures of the above product were validated with the participation of the WELDING INSTITUTE, an independent French inspection office, "Technical Report #40167 and #40171, March, 11th 2003". These reports are part of the development documentation of the ARCBUMP, reserved for L-ACOUSTICS internal use.

L-ACOUSTICS has engineered the ARCBUMP using state of the art modeling and calculation software. The ARCBUMP was also destructively tested to validate its final design using a pulling bench equipped with laboratory calibrated measuring cells.

L-ACOUSTICS hereby declares that the above product conforms to :

1. **The Machinery Directive 98/37/CE**, Part 4 : Lifting Accessories
2. **Rules for the Design of Hoisting Appliances**, European Federation of Materials Handling and Storage Equipment (FEM 1.001).

Established at Marcoussis, France, on the 28th of April 2003

Signature of L-ACOUSTICS representative :

Jacques Spillmann
Chief Engineer - Manufacturing

11/2003

DCE-ARCBUMP - page 2/2

Figure 51 : ARCBUMP Rigging Certification